

1960

# SKIN & SCUBA DIVING EQUIPMENT



**The Recognized Leader in  
Quality Equipment for  
The Underwater Sportsman**

3659 Seventh Avenue, Los Angeles 18, Calif.  
Philadelphia, Pennsylvania; Chicago, Illinois



When I accepted the position as Director of sports diving research and development at Healthways, I was motivated by the increasing specialization of underwater equipment and a desire to bring to divers everywhere the finest, most advanced, most thoroughly tested equipment in existence.

It has been a long time since the only equipment a diver used was a mask and hand spear. There has been great progress since those days but there are still many problems to be solved. At Healthways now, there are three particular projects in which we are hard at work on research and development.

First, and most important, is further development of the Self Contained Underwater Breathing Apparatus. There is a vital need for units that will permit us to stay under water longer and operate at greater depths. Our regulators this year will be completely new . . . combining greater ease of operation and safety factors never before available.

Second, there is the problem of underwater communication. "The Silent World" is a very poetic phrase but now we must break the silence and talk underwater. The added safety and convenience brought about by use of Healthways' new underwater communications system will be a giant step forward in underwater sport.

The third problem is underwater transportation. We need an underwater vehicle that is safe, comfortable and easy to maneuver. I believe you will agree when you see Healthways' answer to this problem that all three of these requirements have been met.

Healthways is developing equipment that solve not only these problems but many, many others.

Safety in diving equipment is an absolute requirement. All our products will be developed with this most important factor in mind. I personally will supervise the rigid and thorough testing of all equipment, not only for safety but for perfect functioning and dependable service.

As a pioneer diver who likes his fellow divers, I assure you that all items offered for sale by Healthways will be the finest, most advanced and most thoroughly tested equipment in existence.

**GUSTAV DALLA VALLE**

## GOGGLES AND MASKS



**NO. 1205**  
PROFESSIONAL MASK  
Retail \$3.95

**NO. 1206**  
PROFESSIONAL DELUXE MASK  
Retail \$4.95

The Professional Mask with a double strength glass lens and the Professional Deluxe Mask with a tempered glass safety lens offer extra heavy duty French blue rubber construction that provides a perfect seal and a comfortable fit.



**NO. 1204**  
AQUA-PRO MASK  
Retail \$3.50

The triangular shape of the Aqua-Pro mask gives it a perfect fit for every face. Molded of special compound blue rubber with a clear triangle shatterproof lens.



**NO. 1210**  
AQUA KING MASK  
Retail \$2.95

Outstanding in design and fit, the Aqua King is molded of natural amber gum rubber with a clear oval shatterproof styrene lens.



**NO. 1202**  
AQUA CHAMP SR. MASK  
Retail \$1.50

Leading in popularity, this perfect fitting round mask features top quality special compound blue rubber with a clear, round shatterproof lens.



**NO. 1201**  
AQUA CHAMP SPECIAL MASK  
Retail \$1.00

This popular junior mask is a perfect fitting, top quality blue rubber mask with exclusive bend-edge design and clear styrene lens.



**NO. 1211**  
PROFESSIONAL MASK  
Retail \$3.95

**NO. 1212**  
PROFESSIONAL DELUXE MASK  
Retail \$4.95

The Professional Mask with double strength glass lens and the Professional Deluxe Mask with a Tempered Glass Safety Lens offer extra-heavy duty construction in amber gum rubber that guarantees maximum comfort and seal.



3669 Seventh Avenue  
Los Angeles 18, California

## GOGGLES AND MASKS



**NO. 1241**  
OSTRICA MASK  
Retail \$4.95

The Cressi Ostrica Mask—the finest and most thoroughly approved mask for all-around dependability, sturdiness and safety. The Ostrica offers safety control head strap, Safety Yellow rubber, stainless steel band and Tempered Glass Safety Lens.

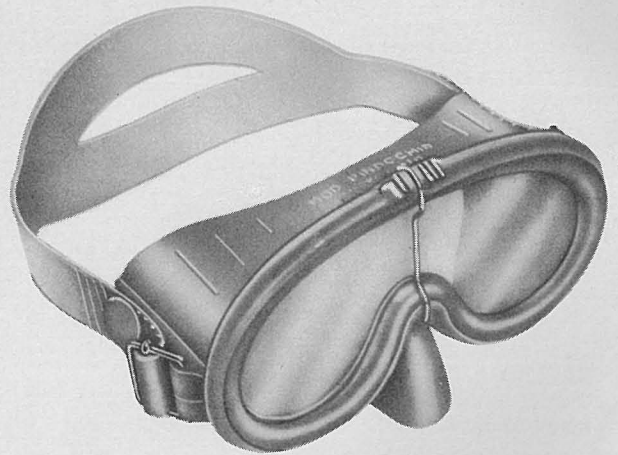

**NO. 1242**  
PINOCCHIO "MODEL 1960" PROFESSIONAL MASK  
Retail \$5.95

Featuring a minimum air displacement, the imported ALL NEW Pinocchio Mask offers up to 25% greater diving depth. The exclusive design allows relief of underwater pressure on the ears. Newly created double seal feather edge makes this mask absolutely leak-proof. Tempered Glass Safety Lens.

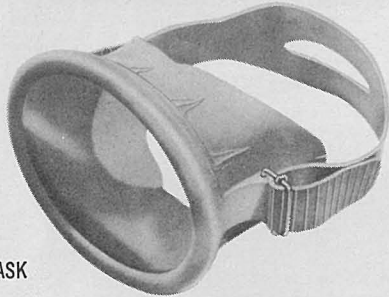

**NO. 1239**  
OSTRICA JR. MASK  
Retail \$2.95

At last a professional mask specifically built for youngsters, women, and the smaller face. The Ostrica Jr. and Ostrica Bantam are made of safety Yellow Rubber and equipped with Tempered Glass Safety Lens.

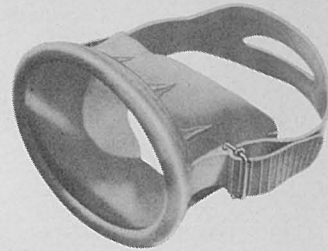

**NO. 1240**  
OSTRICA BANTAM MASK  
Retail \$2.50

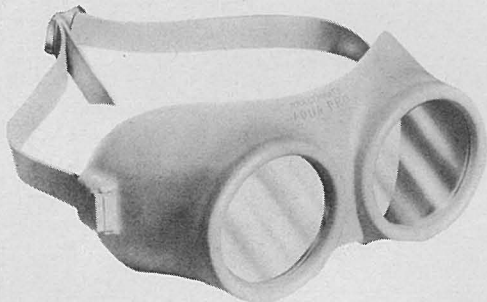

**NO. 1107**  
AQUA-PRO GOGGLE  
Retail \$1.95

The finest professional goggles — made of yellow safety rubber with a Tempered Glass Safety Lens. The goggles preferred by swimmers everywhere.

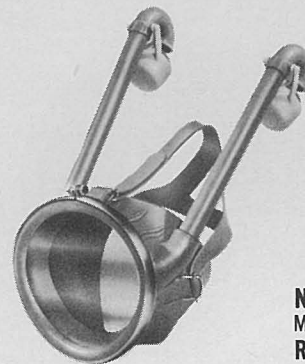

**NO. 1235**  
MEDUSA TWIN SNORKEL MASK  
Retail \$9.95

Here is the world's leading shallow water, wide view, full face twin snorkel mask. Perfect for underwater observation, the Medusa offers Cressi Blue Rubber, a contour safety strap and Tempered Glass Safety Lens.

Healthways brings you the latest exclusive designs in masks created by Peche-Sport, Marseilles, France — masks that lead the field in style, construction and performance.

## FRENCH IMPORTED MASKS

### *The Compensator*

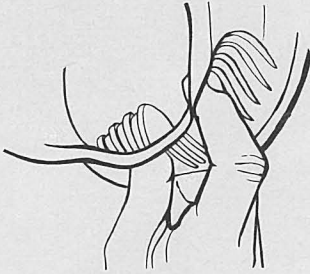

**NO. 1223**  
THE COMPENSATOR  
FRENCH BLUE  
Retail \$5.95

**NO. 1253**  
THE COMPENSATOR  
SAFETY YELLOW  
Retail \$5.95

Combining the outstanding features of all the world famous French masks, the Compensator, with its feather edge offers a perfect fit, the wide-angle vision of the Panoramique, PLUS the exclusive finger wells that provide an easy grasp of the nose to relieve water pressure on the ears. French Blue Rubber, or Safety Yellow, stainless steel band and Tempered Glass Safety Lens.



### *The Espadon*



**NO. 1220**  
ESPADON MASK  
FRENCH BLUE  
Retail \$3.95

**NO. 1250**  
ESPADON MASK  
SAFETY YELLOW  
Retail \$3.95

One of Europe's leading masks designed primarily for the smaller faces, the Espadon features light-weight construction with a comfortable feather edge fit. French Blue Rubber, or Safety Yellow, stainless steel band and Tempered Glass Safety Lens.

### *The Panoramique*

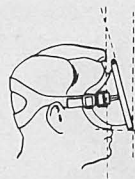

**NO. 1222**  
PANORAMIQUE "WIDE-ANGLE" MASK  
FRENCH BLUE  
Retail \$4.95

**NO. 1252**  
PANORAMIQUE "WIDE-ANGLE" MASK  
SAFETY YELLOW  
Retail \$4.95

The exclusive design of the Panoramique, Europe's most popular mask, brings the Tempered safety glass lens closer to the eyes at a slant that offers undistorted vision over a wider range. The contour type strap and feather edge of the mask make a comfortable, watertight fit. French Blue Rubber, or Safety Yellow, stainless steel band and Tempered Glass Safety Lens.



3669 Seventh Avenue  
Los Angeles 18, California

## CRESSI RONDINE FINS

### The Mediterranean

Made of the newest floating compound, Cressi Blue Gum Rubber, Cressi Mediterranean Fins combine the comfort, the fin tip rigidity and the lightness in weight desired by everyone.



| NO.  | SHOE SIZES | RETAIL |
|------|------------|--------|
| 1350 | 5-7        | 9.95   |
| 1351 | 7-9        | 9.95   |
| 1352 | 9-11       | 10.95  |
| 1353 | 11-13      | 11.95  |

Created by the world's leading manufacturers of underwater sports equipment the Cressi Rondine line has worldwide acceptance as the finest in design, construction, fit and performance.

### The Garibaldi

This revolutionary new "safety" fin is made of brilliant Cressi yellow rubber which offers the greatest visibility even in the murkiest water. Exceptionally lightweight, the Garibaldi offers greater fin tip rigidity and all the advantages of the newest floating compound.



| NO.  | SHOE SIZE | RETAIL |
|------|-----------|--------|
| 1376 | 2-3       | \$6.95 |
| 1377 | 3-4       | 6.95   |
| 1378 | 4-5       | 8.95   |
| 1360 | 5-7       | 10.95  |
| 1361 | 7-9       | 11.95  |
| 1362 | 9-11      | 11.95  |
| 1363 | 11-13     | 12.95  |
| 1364 | 13-16     | 12.95  |

*Joan 5 1/2 - 6*

### The Genoa

The original black rubber fin that has become a world-wide leader in popularity, the Genoa is scientifically designed to provide the maximum propulsion from its fin tip and side rigidity and at the same time offer form fitting comfort.



| NO.               | SHOE SIZE | RETAIL |
|-------------------|-----------|--------|
| 1330 (No Strap)   | 5-7       | \$7.95 |
| 1331 (No Strap)   | 7-9       | 7.95   |
| 1334 (Adj. Strap) | 9-11      | 8.95   |
| 1335 (Adj. Strap) | 11-13     | 8.95   |

### The Competition

The outstanding fin for the competitive diver, this Cressi model offers greater propulsion for less leg action. Made of a combination of rubber textures the Competition fins give the fin tip rigidity and foot comfort desired by the experienced sports diver. With adjustable strap.



| NO.  | SHOE SIZE | RETAIL  |
|------|-----------|---------|
| 1355 | 7-9       | \$10.95 |
| 1356 | 9-11      | 12.95   |
| 1357 | 11-13     | 12.95   |
| 1358 | 13-16     | 12.95   |



**NO. 1237**  
CRESSI MINIATURE RONDINE  
FINS AND MASK SET  
These detail scale miniatures of the real thing are much sought after mementos. A natural for premiums or promotions. Blue.  
**Retail .75**

## FINS and Accessories

### WATER DOGS FINS

Combining quality, design and appearance, Healthways Water Dogs offer extra durability and lightness — an ideal all around fin with a fully adjustable non-slip safety buckle and strap. Molded of special compound blue rubber.



**NO. 1303** Sizes 4-8

**NO. 1304** Sizes 8-13

**Retail \$3.95 pr.**

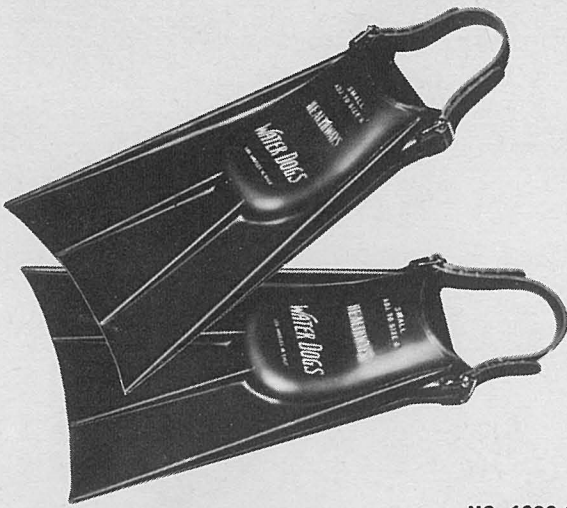

**NO. 1302** Small  
Adj. to Size 6

**Retail \$2.95 pr.**

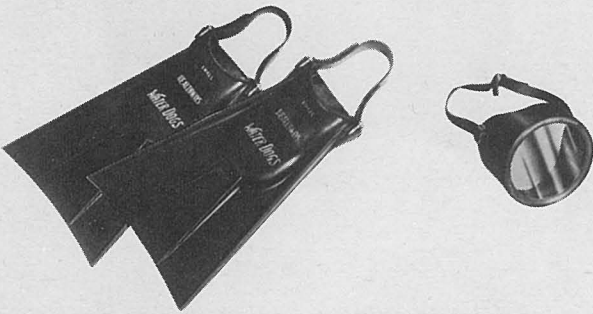

**NO. 1305**  
WATER DOGS SWIM SET  
**Retail \$3.95**

Priced to fit everyone's pocketbook — designed to meet the needs of every youngster, the Water Dogs Swim Set includes 1 pair of No. 1302 Fins adjustable to size 6 and 1 No. 1201 Mask. Special compound blue rubber.

### WEB FEET FINS

Proven in popularity year in — year out Healthways new, improved Web Feet Fins offer the finest in comfort, utility and performance. Molded of the finest amber natural gum rubber.

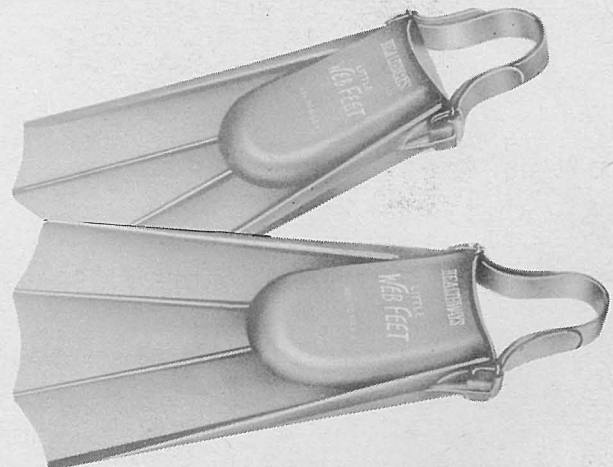

**NO. 1306**  
LITTLE WEB FEET  
Adj. to Size 6  
**Retail \$3.95 pr.**

**NO. 1307**  
Sizes 4-8  
**Retail \$4.95 pr.**

**NO. 1308**  
Sizes 8-13  
**Retail \$4.95 pr.**



3669 Seventh Avenue  
Los Angeles 18, California

## SKIN DIVING ACCESSORIES

FIXE PALM (Pat.)—A universal strap for added fin security. The latest development to hold any closed-heel type fin to your foot under the most turbulent conditions. The fin is held in three places—instep, arch, and heel. Prevents heel of fin from slipping off.

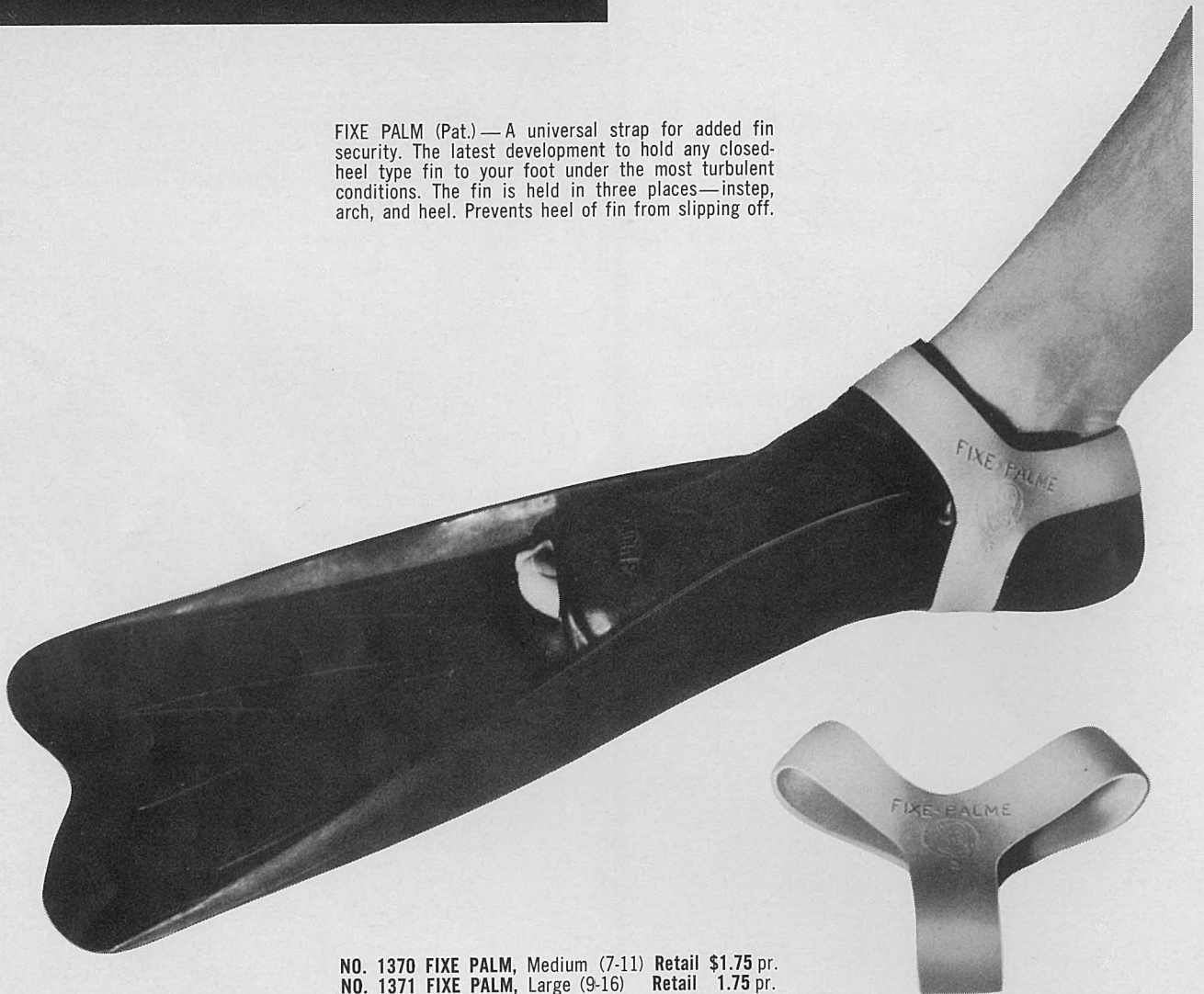

NO. 1370 FIXE PALM, Medium (7-11) Retail \$1.75 pr.  
NO. 1371 FIXE PALM, Large (9-16) Retail 1.75 pr.

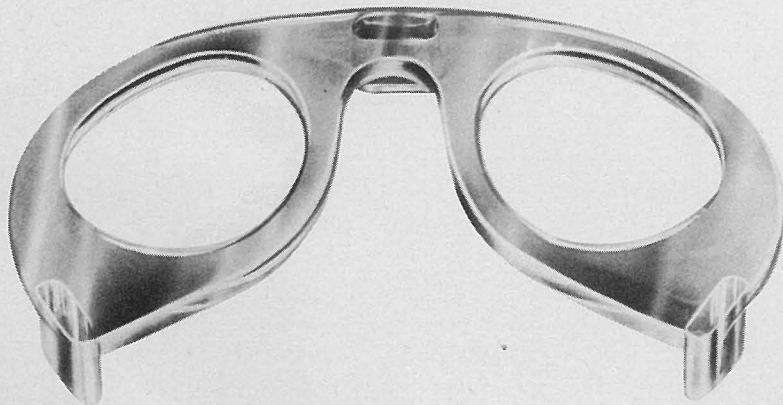

NO. 1961  
PRESCRIPTION LENS HOLDER  
Retail \$2.95

Fits all popular standard masks. Permits the diver who wears eyeglasses to adapt mask to fit his vision.



# SKIN DIVING ACCESSORIES

The original and most efficient exhaust valve type snorkel. Soft mouthpiece. Polyethylene cage with rubber ball. Rubber headband.

**NO. 1401**  
TAHITI SNORKEL  
Retail \$2.50

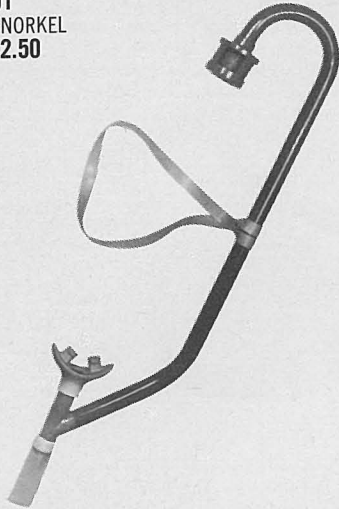

Offering all the safety features of professional type equipment, the Aqua Champ Snorkel has a soft rubber mouthpiece, polyethylene cage with rubber ball and a rubber headband.

**NO. 1402**  
AQUA CHAMP SNORKEL  
Retail \$1.59

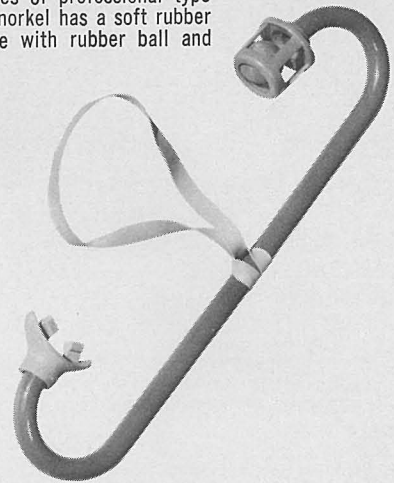

The Delfino Snorkel features a one-piece rubber elbow and mouthpiece, a rigid plastic blue centerpiece and a flexible upper section of grey gum rubber.

**NO. 1430**  
CRESSI DELFINO SNORKEL  
Retail \$1.95



Straight professional type snorkel of rigid polyethylene with a soft polyethylene mouthpiece.

**NO. 1403**  
SEA SCOUT SNORKEL  
Retail \$1.00

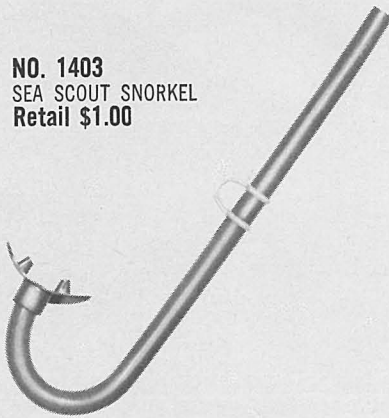

**NO. 1408-07**  
PROFESSIONAL SNORKEL MOUTHPIECE  
Retail \$1.00



The choice of professional divers in both style and construction, the Haiti Snorkel is made of the finest quality yellow rubber. Equipped with No. 1408-07 Professional Mouthpiece.

**NO. 1432**  
HAITI PROFESSIONAL SNORKEL  
Retail \$1.95

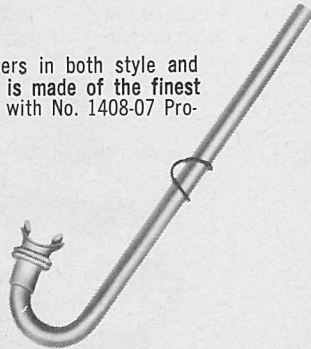

**NO. 1930**  
CRESSI PROFESSIONAL NOSE CLIPS  
(Pure Gum Rubber—Standard Size)  
Retail \$ .75

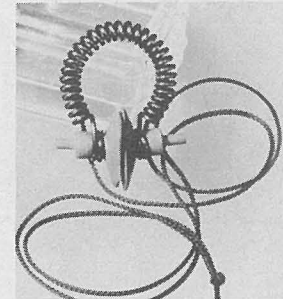

**NO. 1928**  
EAR STOPPLES  
(Assorted Sizes)  
Retail \$ .25 pr.

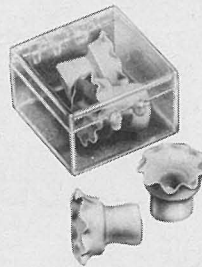

**NO. 1938**  
SNORKEL HOLDER  
Retail \$.25

The newest and best-designed snorkel holder.

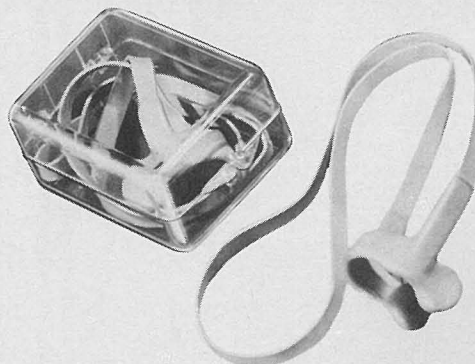

**NO. 1915**  
NOSE CLIPS  
Pure Latex  
(Standard Size)  
Retail \$ .50



3669 Seventh Avenue  
Los Angeles 18, California

**SEA DIVE**  
**Swim and Water**  
**Sports Accessories**



**NO. 1104**  
 SEA DIVE JR. GOGGLES  
 Retail \$.69

Designed especially for youngsters, the Sea Dive Jr. Goggles offers full protection from salt and chlorinated water — fully adjustable strap.

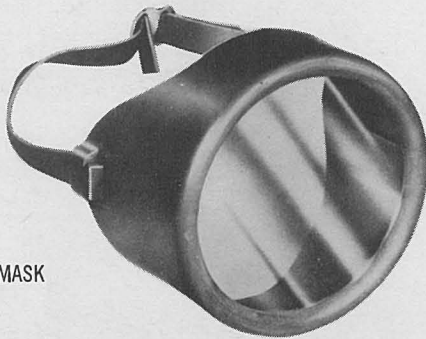

**NO. 1216**  
 SEA DIVE JR. MASK  
 Retail \$.98

For the smaller faces — women and children, the Sea Dive Jr. Mask offers the exclusive bend-edge contour with wide-vision molded safety lens and a fully adjustable strap. Blue compound rubber.



**NO. 1214**  
 SEA DIVE SUB-MARINE TWIN SNORKEL MASK  
 Retail \$4.95

Leading the popular priced field in twin snorkel masks, the Sea Dive Sub-Marine is a shallow water mask molded of blue rubber compound with a full-vision molded safety lens.

*Professional Design*  
*at Popular Prices*

Healthways Sea Dive line offers the finest in popular priced swim and water sports accessories. Each item is individually packaged in an easy-vision polyethylene bag.



**NO. 1105**  
 SEA DIVE SR. GOGGLES  
 Retail \$.89

The popular priced swim goggle. The Sea Dive Sr. Goggles fit swimmers of all ages. Molded in blue compound rubber with fully adjustable strap and molded safety lenses.



**NO. 1217**  
 SEA DIVE SR. MASK  
 Retail \$1.39

Molded in attractive "Sea Dive Blue" compound rubber this model is designed to fit all faces . . . all ages. Scientific bend-edge contour assures perfect fit — full vision molded safety lens with adjustable strap.



**NO. 1218**  
 SEA DIVE PRO MASK  
 Retail \$1.98

A professional design for experts! Molded in attractive "Sea Dive Blue" compound rubber! Design, fit never before available in a popular priced dive mask! Full wide-vision oval molded shatter-proof safety lens! Extra wide flange with feather edge contour — perfect comfort.



**SEA DIVE**  
**Swim and Water**  
**Sports Accessories**

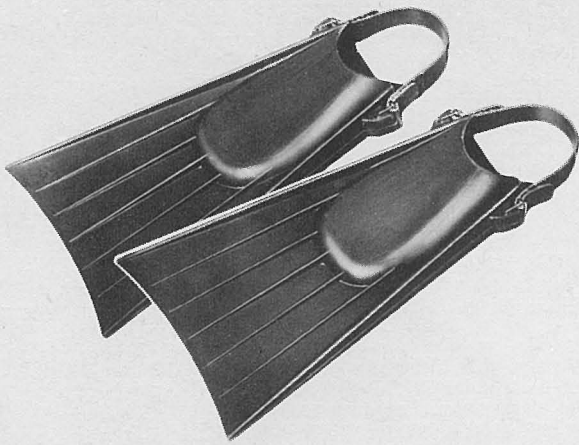

**NO. 1326** (medium)  
 Shoe Size 4-8  
**NO. 1327** (large)  
 Shoe Size 8-13  
 SEA DIVE SR. FROG FEET  
**Retail \$2.98 pr.**

Adult size swim fins of fine quality blue compound rubber with non-slip safety buckle and strap.

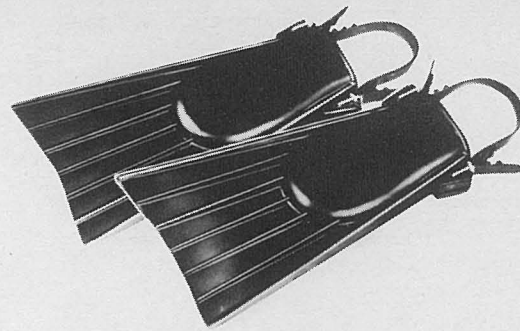

**NO. 1325**  
 SEA DIVE JR. FROG FEET  
**Retail \$1.98 pr.**

Molded of blue compound rubber the Sea Dive Jr. Frog Feet are professionally designed. Non-slip safety buckle and strap — adjustable to shoe size 7.

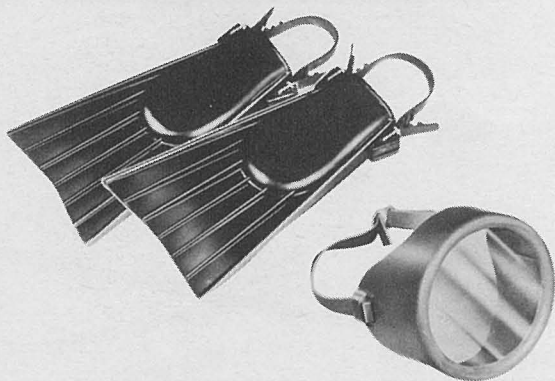

**NO. 1317**  
 SEA DIVE JR. SWIM SET  
**Retail \$2.95**

An ideal mask and fin combination for the younger set. Includes 1 pair of No. 1325 Sea Dive Jr. Frog Feet, adjustable to shoe size 7 and 1 No. 1216 Sea Dive Jr. Mask.



**NO. 1405**  
 SEA DIVE STANDARD SNORKEL  
**Retail \$1.00**

Every characteristic of safety and quality are built into the Sea Dive Snorkel. Cage and mouthpiece are molded of soft vinyl material.

| HEALTHWAYS SEA DIVE REPLACEMENT PARTS |                                     | RETAIL EACH |
|---------------------------------------|-------------------------------------|-------------|
| <b>1104</b>                           | <b>Junior Goggle</b>                |             |
| 1104-02                               | Plastic Lens — Shatterproof         | \$ .10      |
| -03                                   | Straps                              | .15         |
| -04                                   | Strap Buckles                       | .06         |
| <b>1105</b>                           | <b>Senior Goggle</b>                |             |
| 1105-02                               | Plastic Lens — Shatterproof         | .11         |
| -03                                   | Straps                              | .15         |
| 1104 -04                              | Strap Buckles                       | .06         |
| <b>1201</b>                           | <b>Junior Mask</b>                  |             |
| 1201-02                               | Plastic Lens                        | .27         |
| -03                                   | Straps                              | .15         |
| 1104-04                               | Strap Buckles                       | .06         |
| <b>1217</b>                           | <b>Senior Mask</b>                  |             |
| 1217-02                               | Plastic Lens,                       | .30         |
| -03                                   | Straps                              | .15         |
| 1104-04                               | Strap Buckles                       | .06         |
| <b>1218</b>                           | <b>Sea dive Pro Mask</b>            |             |
| 1218-02                               | Lens Clear Oval Styrene             | .40         |
| 1218-03                               | Strap                               | .15         |
| 1210-04                               | Buckle                              | .06         |
| <b>1214</b>                           | <b>Sub-Marine Twin Snorkel Mask</b> |             |
| 1210-02                               | Plastic Lens — Shatterproof         | .67         |
| 1214-03                               | Straps                              | .38         |
| 1210-04                               | Strap Buckle                        | .06         |
| <b>1325</b>                           | <b>Junior Frog Feet</b>             |             |
| 1325-03                               | Straps                              | .38         |
| 1302-04                               | Strap Buckles                       | .06         |
| <b>1326-1327</b>                      | <b>Senior Frog Feet</b>             |             |
| 1326-03                               | Straps                              | .38         |
| 1303-04                               | Strap Buckles                       | .06         |



3669 Seventh Avenue  
 Los Angeles 18, California

# SPEAR FISHING GUNS



**NO. 1502**  
SHARK SLING SPEAR GUN  
(4 ft. Cadmium-Plated Spear)  
**Retail \$4.95**

Modeled after the original Hawaiian design, used for centuries in the South Pacific. Fast - accurate - powerful - high-impact Styrene handle. Non-slip, hand-fitting grip. This gun is ideal for close-in work.

Developed by G. Beauchat, the originator of the arbalette, Espadon Arbaletes are dependable all-around spear fishing guns. Scientifically balanced and designed to float after release of the spear, the Espadon features improved hand-wrapped rubber power slings, tough plastic high impact handles with a positive safety lever and corrosion and rust resistant "Ocean Blue" finish.

## ESPADON ARBALETES (Rubber Powered)

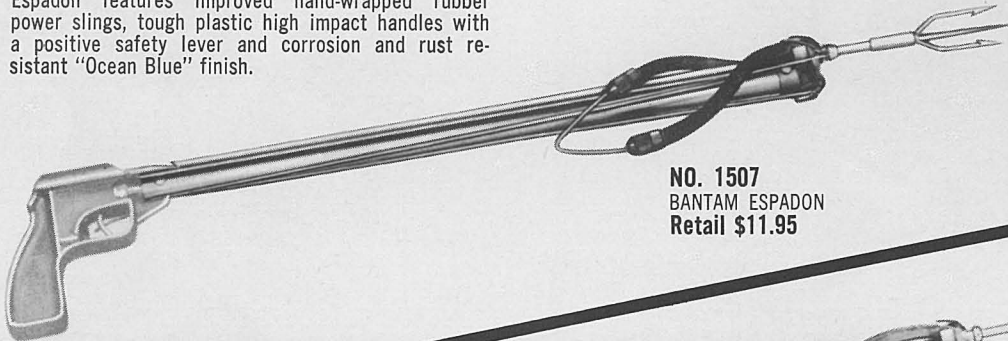

**NO. 1507**  
BANTAM ESPADON  
**Retail \$11.95**

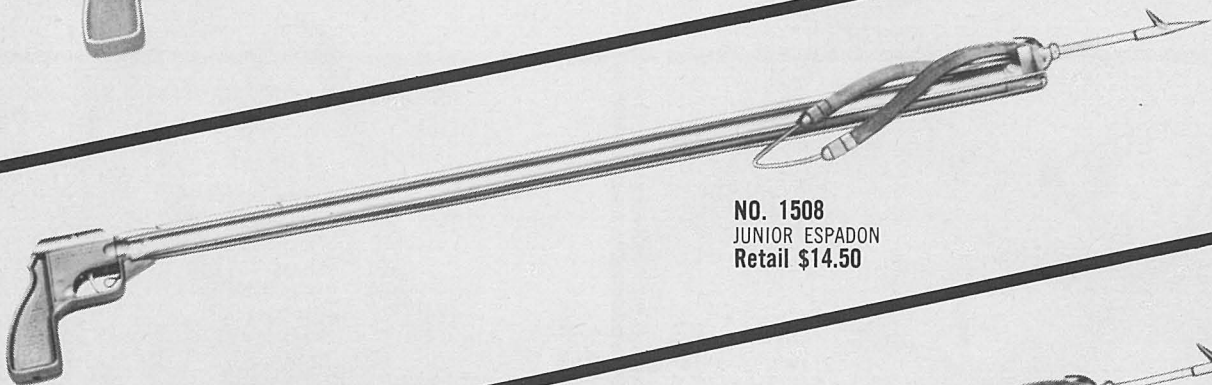

**NO. 1508**  
JUNIOR ESPADON  
**Retail \$14.50**

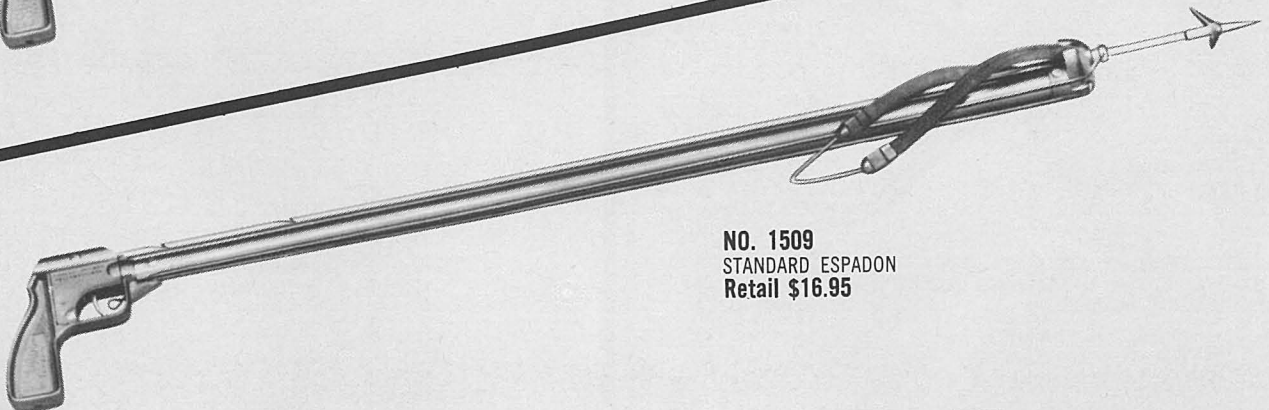

**NO. 1509**  
STANDARD ESPADON  
**Retail \$16.95**

The original all-metal, rust and corrosion resistant gun, Peche-Sport Arbalettes are perfectly balanced to be weightless under water. Featuring a comfortable pistol-grip handle and a positive safety catch. Peche-Sport Arbalettes will float to the surface after the spear has been released.

## SPEAR FISHING GUNS

### PECHE-SPORT ARBALETES (Rubber Powered)

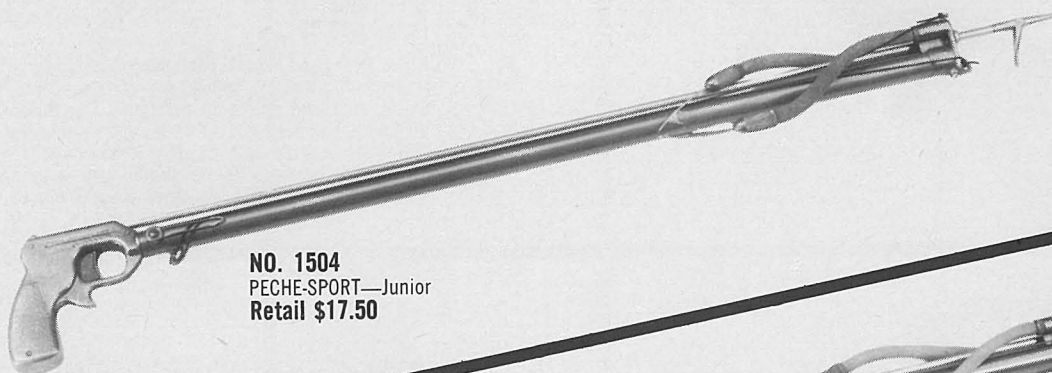

**NO. 1504**  
PECHE-SPORT—Junior  
Retail \$17.50

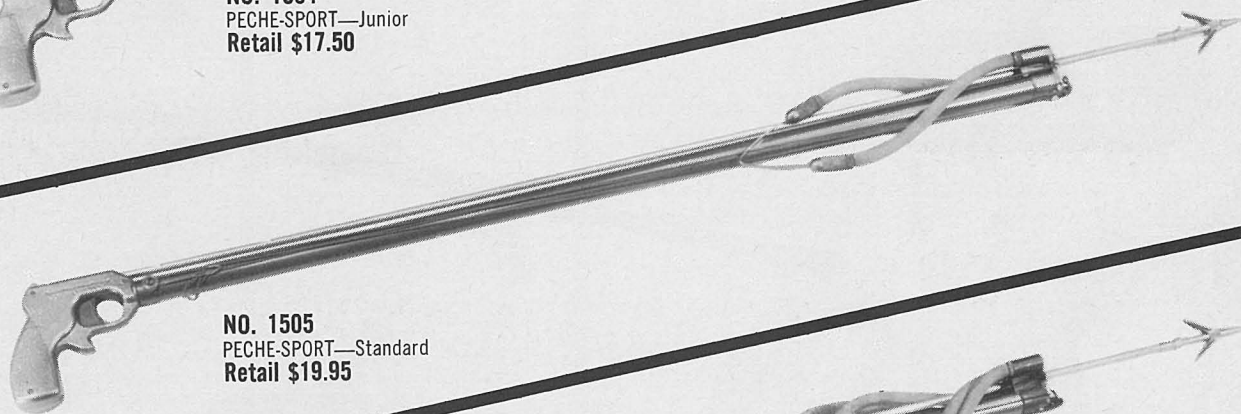

**NO. 1505**  
PECHE-SPORT—Standard  
Retail \$19.95

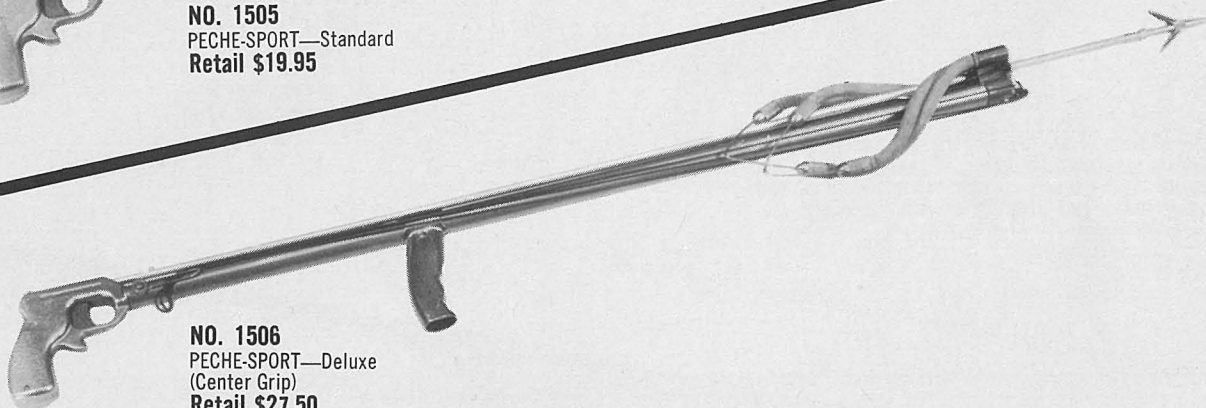

**NO. 1506**  
PECHE-SPORT—Deluxe  
(Center Grip)  
Retail \$27.50

### SPEARHEADS

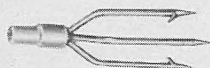

**NO. 1507-02**  
TRI-POINT SPEARHEAD  
Retail \$1.75



**NO. 1504-02**  
SINGLE BARB SPEARHEAD  
Retail \$ .98



**NO. 1505-02**  
DOUBLE BARB SPEARHEAD  
Retail \$1.98



**NO. 1513-10**  
ARBALETE SPEARHEAD ADAPTER  
(Permits use of all Arbalette-type Spearheads)  
Retail \$ .75



3669 Seventh Avenue  
Los Angeles 18, California

All Spearheads Interchangeable For Use  
On Espadon or Peche Sport Arbaletes

## SPEAR FISHING GUNS

**TWO GUNS IN ONE!  
GIVES YOU THAT SECOND SHOT  
WITHOUT HAVING TO RELOAD!**

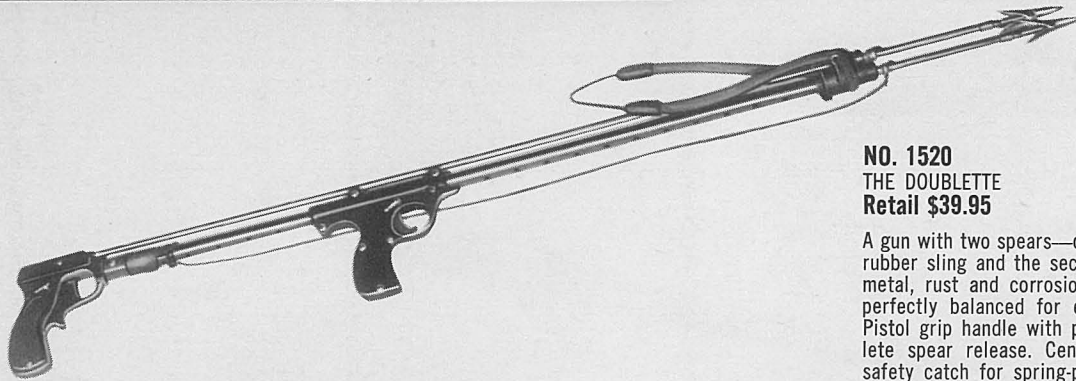

**NO. 1520**  
THE DOUBLETTE  
Retail \$39.95

A gun with two spears—one spear powered by arbalete rubber sling and the second by an internal spring. All metal, rust and corrosion resistant. The Doublette is perfectly balanced for ease in underwater handling. Pistol grip handle with positive safety catch for arbalete spear release. Center pistol grip with positive safety catch for spring-powered spear release.

## CRESSI SPEAR GUNS



**NO. 1534**  
DELUXE MIGNON—All Metal  
(Internal Rubber Powered)  
Retail \$19.95

Only 34" in length, the Deluxe Mignon is easy to handle, charge and operate. Internally rubber powered, this model is ideal for "close-in" work. Constructed of corrosion-resistant anodized metal. Diameter: 0.86", Spear Dia. 0.40".

Imported from Italy, Cressi guns are recognized as the finest in quality, accuracy and power. All guns are complete with spear, spearhead, nylon line and charger. The center pistol grip provides perfect balance for accuracy.



**NO. 1531**  
SAETTA  
(Spring Powered)  
Retail \$24.95

Unusually accurate, highly maneuverable and easily charged, the Saetta is internally spring powered. Non-corrosive construction throughout. Length 45", Dia. 0.66", Spear Dia. 0.39".

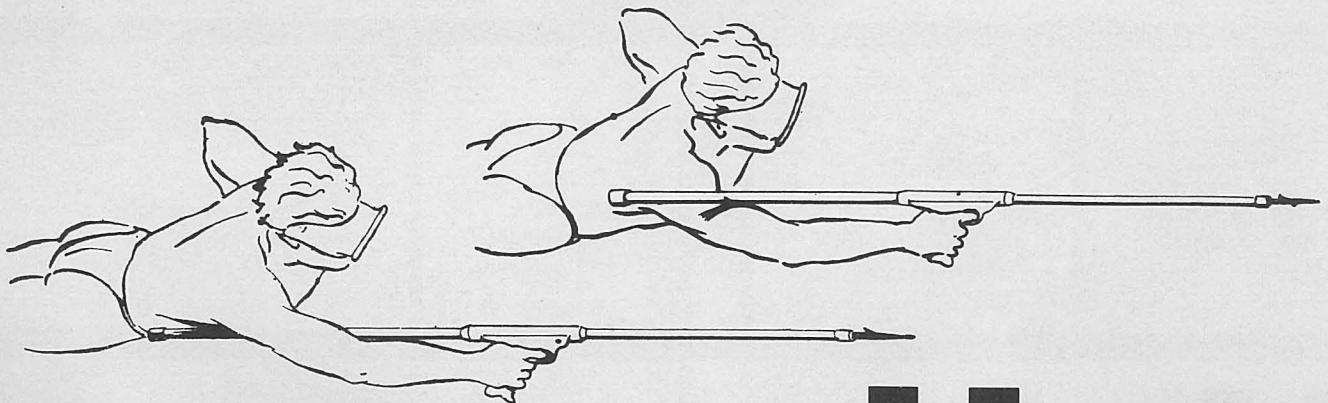

Famous the world over for their fine quality these spearheads are interchangeable for all Cressi spears and with the use of No. 1500-10 Adapter may be used on French Arbalette Spearshafts.

## CRESSI SPEARHEADS



**NO. 1533-02**  
TWO BARB  
Retail \$1.95



**NO. 1534-02**  
SINGLE BARB  
Retail \$1.25

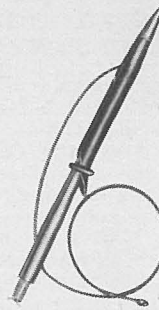

**NO. 1512-02**  
DETACHABLE HEAD  
Retail \$3.75

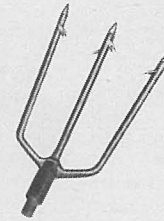

**No. 1500-02**  
THREE PRONG  
Retail \$1.25

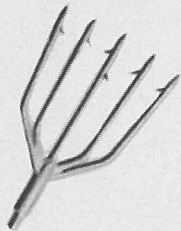

**NO. 1511-02**  
FIVE PRONG  
Retail \$1.75

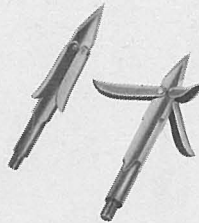

**NO. 1500-06**  
THREE BARB STAR  
Retail \$4.50



**NO. 1530-01**  
SPEARHEAD TIP  
(Fits all Cressi spearheads)  
Retail \$ .40



**NO. 1500-10**  
SPEARHEAD ADAPTER SLEEVE  
(Permits Cressi spearheads to be used on any Peche-Sport or other French Arbalette Spearshafts)  
Retail \$ .75

## CHARGER and LINE

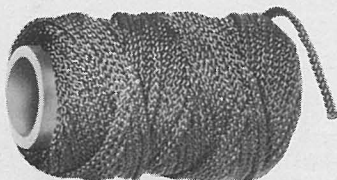

**NO. 1591**  
NYLON LINE  
200 lb. Test 150 ft. Spool  
Retail \$5.25

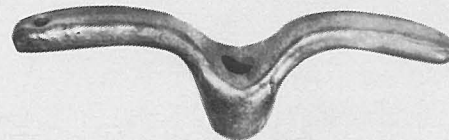

**NO. 1590**  
ALUMINUM CHARGER  
For Cressi Spring Guns  
Retail \$1.00



3669 Seventh Avenue  
Los Angeles 18, California

# UNDERWATER BREATHING APPARATUS



## THE SCUBAIR SINGLE HOSE TWO-STAGE REGULATOR! THE MOST THOROUGHLY TESTED AND EXPERTLY ENGINEERED SCUBA IN THE HISTORY OF SELF-CONTAINED DIVING!

A minimum of moving parts. The safest, most simple, most compact high-pressure and demand valves. A depth-compensated, automatic, precision air reserve is built into the unit. A high-test nylon and neoprene hose features a swivel-joint connection to the demand regulator. Center opening to diaphragm enabling diver to clear water from unit instantly. Eliminates protruding button that can lead to involuntary loss of air. Air exhaust is channeled so as to give unrestricted exhaling and to prevent air bubbles from obstructing vision. Revolutionary new "Quik-Klip" allows immediate removal of cover to facilitate inspection and maintenance and insures positive seal of diaphragm. All air connections have leakage-preventing "O" Ring seals. Entire unit made of chrome-plated brass with stainless steel springs. Contains attachment for Scubair Pressure Gauge.

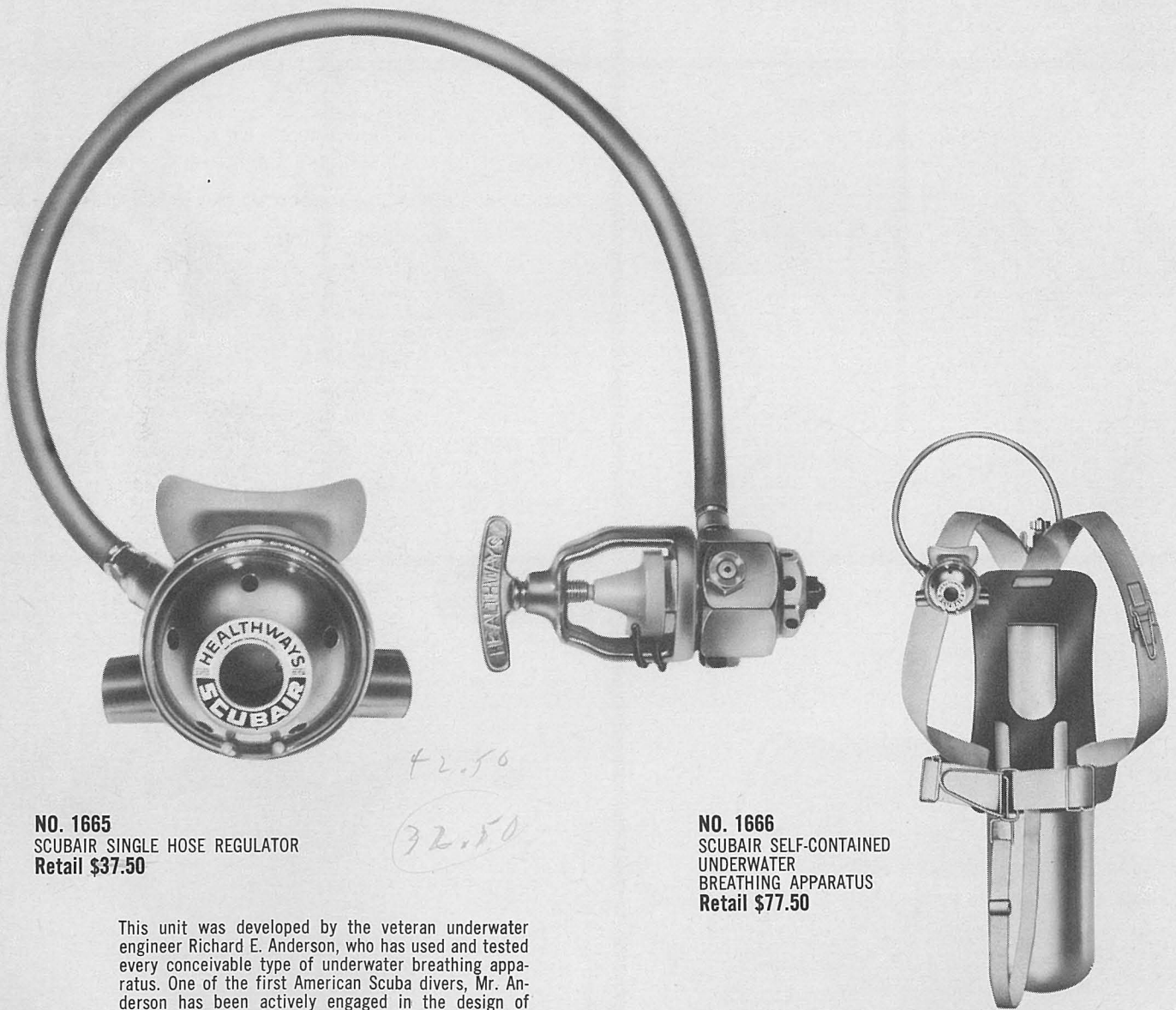

NO. 1665  
SCUBAIR SINGLE HOSE REGULATOR  
Retail \$37.50

42.50  
32.50

NO. 1666  
SCUBAIR SELF-CONTAINED  
UNDERWATER  
BREATHING APPARATUS  
Retail \$77.50

This unit was developed by the veteran underwater engineer Richard E. Anderson, who has used and tested every conceivable type of underwater breathing apparatus. One of the first American Scuba divers, Mr. Anderson has been actively engaged in the design of scientific underwater equipment for many years. His own tests with the SCUBAIR to a depth of 300 feet attest to the mechanical excellence of this unit.





# Scuba

THE SENSATIONAL NEW AIR LUNG

THE MODEL "1960" DELUXE SCUBA is an "all new" product . . . every part has been precision made and engineered to assure maximum efficiency. Each part is made of the finest materials available . . . finest stainless steel, monel, and brass materials have been used exclusively throughout. Built to last . . . there's no possibility of corrosion, electrolysis or other chemical action that would affect the function and utility of the Model "1960" Deluxe SCUBA. One-year factory warranty and lifetime service policy, complete with all details, go with every SCUBA.

A foolproof depth compensated automatic air reserve has been engineered into the regulator itself . . . it will always insure an adequate supply of air to enable the diver to reach the surface. There is nothing to adjust . . . nothing to regulate.

The Model "1960" Deluxe SCUBA has a completely new pressure compensated exhaling valve that assures effortless, equalized exhalation in any position.

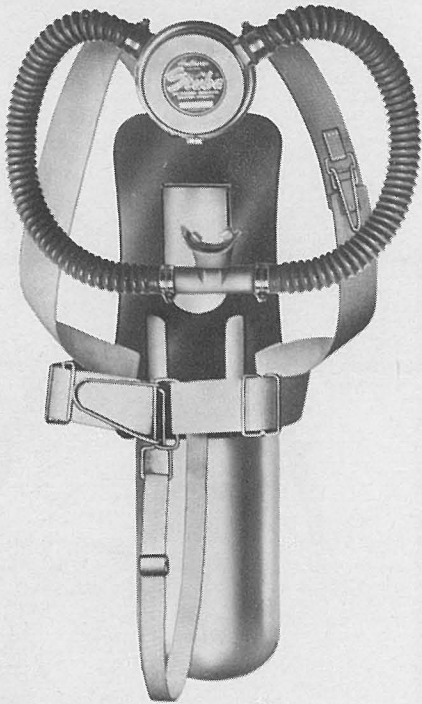

### NO. 1612

MODEL "1960" DELUXE SCUBA SELF-CONTAINED UNDERWATER BREATHING APPARATUS

includes:

No. 1611 Scuba Regulator  
No. 1602 Tank (71.2 cu. ft.—2250 p.s.i.—approx. 1 hour cap.)

No. 1621 Scuba Non-Return Valve  
No. 1603 High Pressure Valve  
No. 1600 Scubapak Harness Complete  
Complete instructions for use and maintenance.

Retail \$112.00

### NO. 1632

Same as above with yellow baked enamel finished tank.

Retail \$117.00

## UNDERWATER BREATHING APPARATUS

### NO. 1611

HEALTHWAYS DELUXE SCUBA REGULATOR COMPLETE "1960 MODEL" COMPLETELY REDESIGNED.

Retail \$52.50

Built-in Depth Compensated Automatic Air Reserve, complete with instructions for use and maintenance.

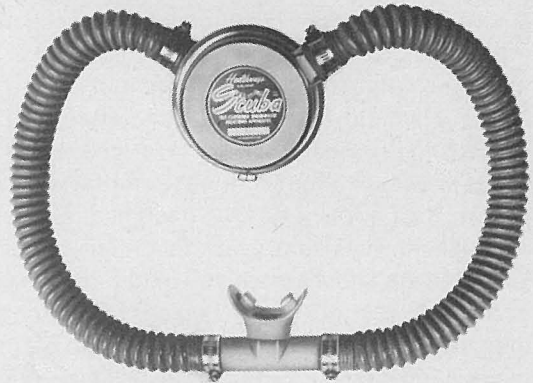

All Healthways SCUBA regulators are factory guaranteed for one year from date of purchase against corrosion, electrolysis or other chemical action that would affect function and utility.



### NO. 1613

MODEL "1960" DELUXE SCUBA TWO-TANK UNDERWATER BREATHING APPARATUS

Includes:

No. 1611 Scuba Regulator  
No. 1621 Scuba Non-Return Valve  
No. 1602 Tanks (2) (71.2 cu. ft.—2250 p.s.i.—Approx. 2 hour cap.)

No. 1603 High Pressure Valves (2)  
No. 1605 Two-Tank Harness complete  
No. 1606 Two Tank Yoke Assembly  
Complete instructions for use and maintenance.

Retail \$176.50

### NO. 1633

Same as above with yellow baked enamel finished tank.

Retail \$186.50

**H**  
Healthways

3669 Seventh Avenue  
Los Angeles 18, California

## SCUBA HARNESS

Completely new design by Richard E. Anderson that combines safety, comfort and utility. The SCUBAPAK is made of a single sheet of specially-compounded corrosion-proof aluminum. A protective smooth-surface coating of resilient high-impact plastic makes the back plate impervious to salt water and the elements. The arrangement of the back plate puts the tank where it should be on the diver's back. The ingenious "continuous strap" arrangement of the harness brings about the most comfortable and secure Scuba harness ever designed. Equipped with Healthways improved Jet-O-Sen quick release buckle and a crotch strap that may be used at the option of the diver. Two easy-to-carry handles, designed as an integral part of the harness, make carrying your Scuba as easy as carrying a suitcase.

## SCUBAPAK New HARNESS

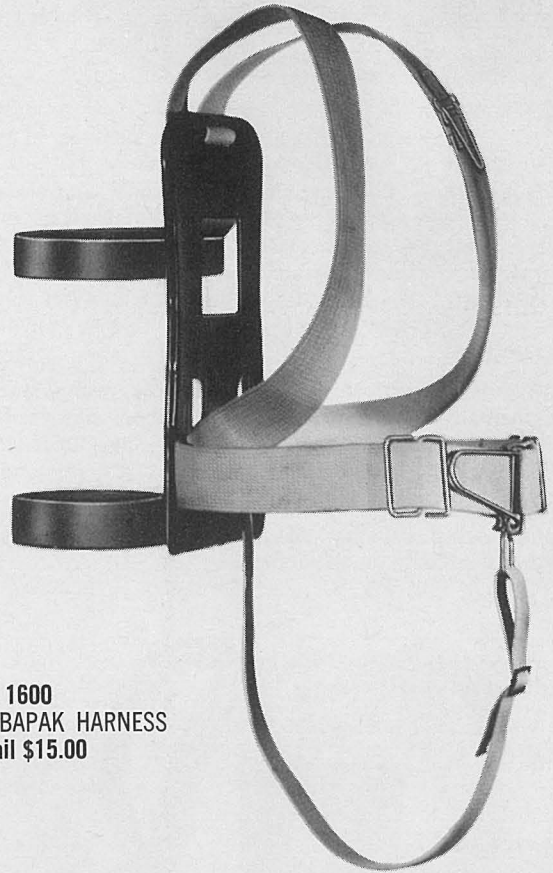

**NO. 1600**  
SCUBAPAK HARNESS  
Retail \$15.00

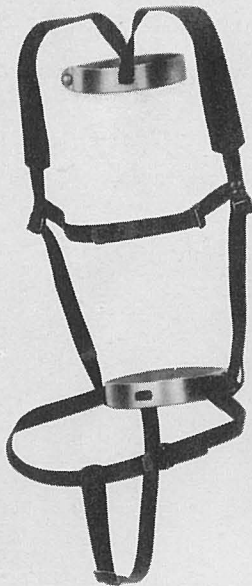

**NO. 1604**  
SINGLE TANK HARNESS  
(Complete with metal bands)  
Retail \$8.95

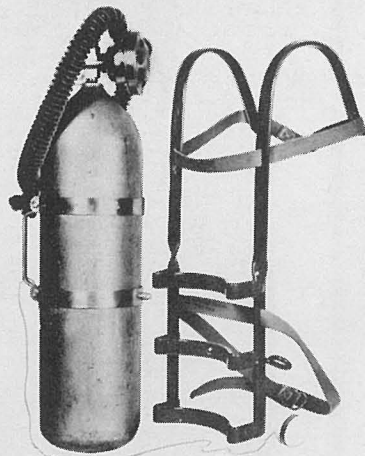

**NO. 1646**  
JET-O-SEN QUICK  
RELEASE SCUBA HARNESS  
(Custom fitting safety harness)  
Retail \$16.95

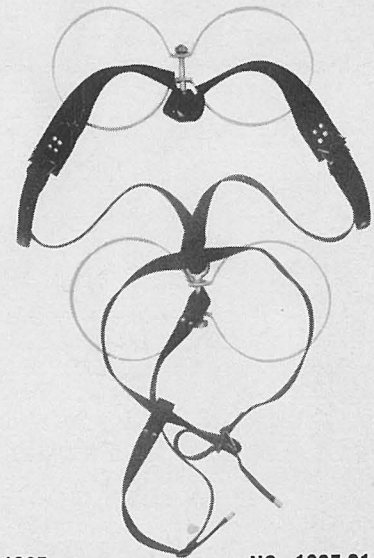

**NO. 1605**  
TWO TANK HARNESS  
(Complete with double  
tank metal bands)  
Retail \$13.95

**NO. 1605-01**  
DOUBLE TANK HARNESS  
(Without metal bands)  
Retail \$6.95

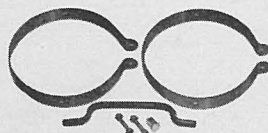

**NO. 1646-15**  
JET-O-SEN BANDS,  
PIN AND HANDLE SET  
Retail \$5.00

**NO. 1605-02**  
DOUBLE TANK METAL BANDS  
Retail \$7.25



3669 Seventh Avenue  
Los Angeles 18, California

## UNDERWATER BREATHING APPARATUS

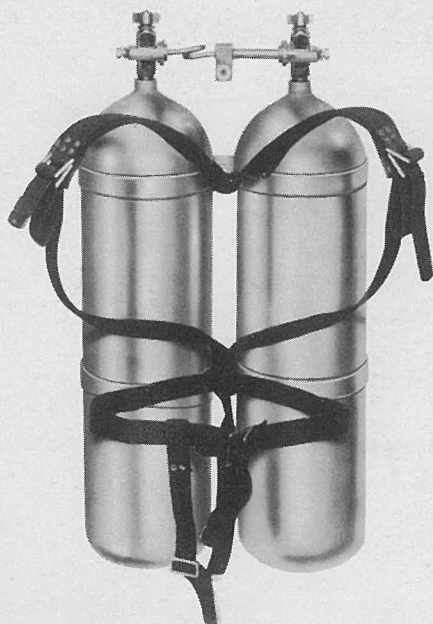

**NO. 1608**  
TWO TANK ASSEMBLY (Filled)  
(Without Regulator)  
Includes:  
No. 1602 Tanks (2) (71.2 cu. ft.—2250 p.s.i.—  
approx. 2 hour cap.)  
No. 1603 High Pressure Valves (2)  
No. 1606 Two Tank Yoke Assembly  
No. 1605 Two Tank Harness Complete  
**Retail \$125.00**

**NO. 1638**  
Same as above with yellow  
baked enamel finished tank.  
**Retail \$135.00**

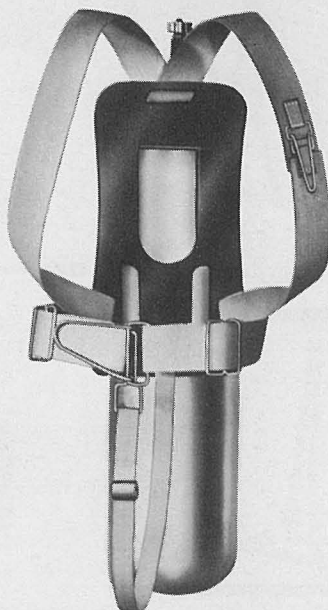

**NO. 1626**  
SINGLE TANK ASSEMBLY (Filled)  
(Without Regulator)  
**Retail \$40.00**

Includes:  
**NO. 1624** Tank, Yellow baked enamel  
finish (38 cu. ft.—1800 psi)  
**NO. 1603** High Pressure Valve  
**NO. 1600** SCUBAPAK Harness  
Complete

**NO. 1627**  
SINGLE TANK ASSEMBLY (Filled)  
(Without Regulator)  
Includes:  
No. 1602 Tank (71.2 Cu. Ft.—2250 P.S.I.  
Approx. 1 hr. cap.)  
No. 1623 Constant Air Reserve Valve  
No. 1603-17 "O" Ring  
**NO. 1600**  
SCUBAPAK HARNESS COMPLETE  
**Retail \$80.00**

**NO. 1657**  
Same as above with yellow  
baked enamel finished tank.  
**Retail \$85.00**

**NO. 1607**  
SINGLE TANK ASSEMBLY (Filled)  
(Without Regulator)  
Includes:  
No. 1602 Tank (71.2 cu. ft.—2250 p.s.i.—  
approx. 1 hour cap.)  
No. 1603 High Pressure Valve  
**NO. 1600**  
SCUBAPAK HARNESS COMPLETE  
**Retail \$59.95**

**NO. 1637**  
Same as above with yellow  
baked enamel finished tank.  
**Retail \$65.00**



**NO. 1602**  
TANK (71.2 cu. ft.—2250 psi)  
(Without High Pressure Valve)  
**Retail \$44.95**

**NO. 1622**  
Same as above with yellow  
baked enamel finished tank.  
**Retail \$49.95**

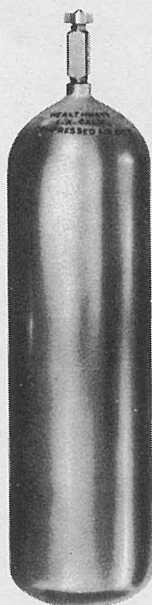

**NO. 1610**  
TANK WITH HIGH PRESSURE VALVE (Filled)  
Includes:  
**NO. 1602 TANK** (71.2 cu. ft.—2250 psi)  
**NO. 1603 HIGH PRESSURE VALVE**  
**Retail \$51.95**

**NO. 1630**  
Same as above with Yellow  
baked enamel finished tank.  
**Retail \$56.95**

**NO. 1625**  
TANK WITH HIGH PRESSURE VALVE  
(Filled)—Yellow Baked Enamel Finish.

Includes:  
**NO. 1624 TANK** (38 cu. ft.—1800 psi)  
**NO. 1603 HIGH PRESSURE VALVE**  
**Retail \$35.00**



3669 Seventh Avenue  
Los Angeles 18, California

# UNDERWATER BREATHING APPARATUS

**NO. 1691**  
DOUBLE TANK  
DISPLAY STAND  
Retail \$7.95

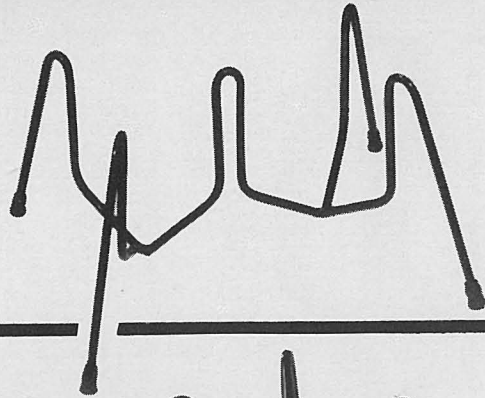

**NO. 1690**  
SINGLE TANK  
DISPLAY STAND  
Retail \$4.95

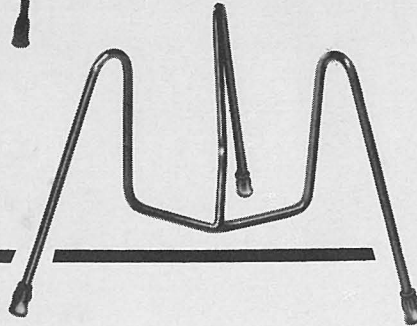

**NO. 1639**  
SCUBA DOUBLE HOSE  
ASSEMBLY  
Retail \$8.95

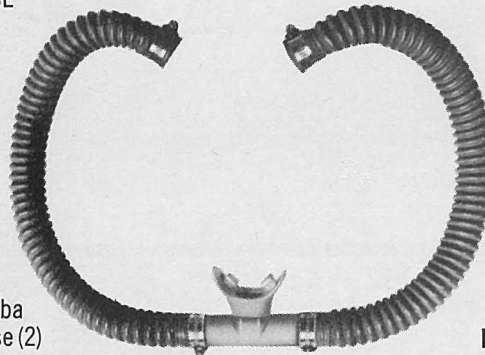

Includes:

- 1601-01 Air-Flo Scuba Breathing Hose (2)
- 1621 SCUBA non-return valve
- 1611-47 Hose Clamp (4)

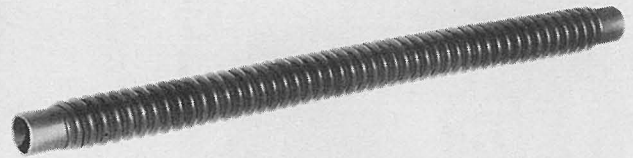

**NO. 1601-01**  
AIR-FLO HOSE FOR SCUBA  
(Sold separately without clamps)  
Special neoprene and pure gum  
rubber—patented spiral principle.  
Retail \$2.50

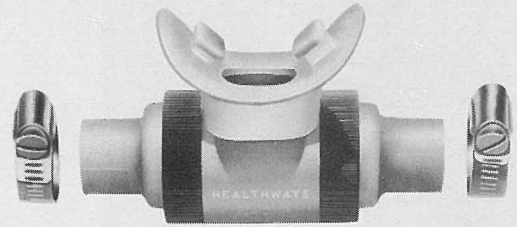

**NO. 1620**  
HOPE-PAGE NON-RETURN VALVE  
Retail \$7.95

**NO. 1620-07**  
MOUTHPIECE—Rubber  
Retail \$1.00

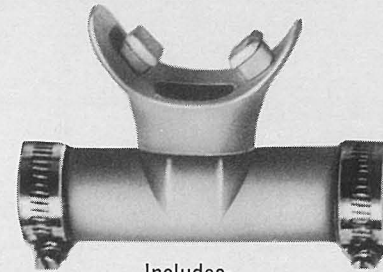

Includes:

- NO. 1621 SCUBA NON-RETURN VALVE  
Retail \$4.95
- 1621-01 Mouthpiece
- 1621-02 Nylon Insert (2)
- 1621-03 Non-Return Rubber Valve (2)
- 1611-47 Hose Clamp (2)



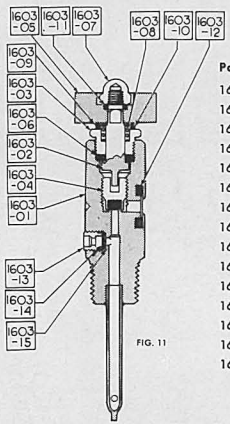
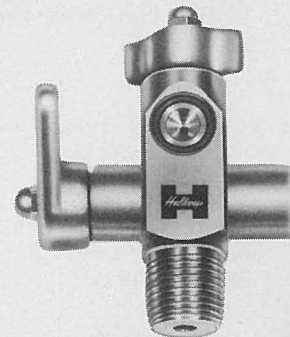

FIG. 11

**CYLINDER VALVE  
PARTS PRICE LIST**

| Part No. | Description         | Retail |
|----------|---------------------|--------|
| 1603-01  | Body                | \$1.40 |
| 1603-02  | Valve Stem          | 1.17   |
| 1603-03  | Packing Nut         | 1.17   |
| 1603-04  | Valve Seat Assembly | 1.40   |
| 1603-05  | Wing Nut            | .84    |
| 1603-06  | Packing Washer      | .70    |
| 1603-07  | Acorn Nut           | .33    |
| 1603-08  | Spring              | .35    |
| 1603-09  | Washer              | .19    |
| 1603-10  | "O" Ring            | .35    |
| 1603-11  | "O" Ring            | .28    |
| 1603-17  | Teflon Washer       | .30    |
| 1603-13  | Safety Plug         | 1.40   |
| 1603-14  | Safety Plug Disc    | .07    |
| 1603-15  | Safety Plug Gasket  | .05    |

**NO. 1603**  
HIGH PRESSURE VALVE  
Retail \$6.95



**NO. 1623**  
NEW SCUBA CONSTANT  
AIR RESERVE VALVE  
Retail \$30.00



3669 Seventh Avenue  
Los Angeles 18, California

# UNDERWATER BREATHING APPARATUS

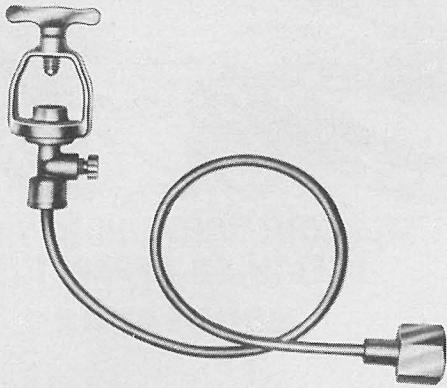

**NO. 1692**  
TANK FILLER ATTACHMENT WITH BLEEDER VALVE  
(Complete with yoke. Connects tank to any  
standard compressed air supply fitting)  
**Retail \$7.95**

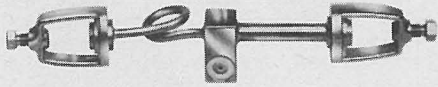

**NO. 1606**  
TWO TANK YOKE ASSEMBLY  
(Standard pigtail type)  
**Retail \$14.95**

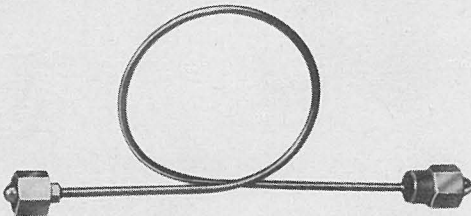

**NO. 1697**  
PIGTAIL CONNECTION  
**Retail \$4.95**

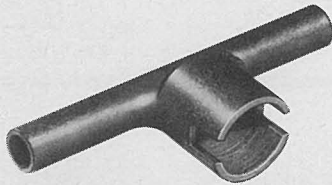

**NO. 1699**  
"EASY-TURN" REGULATOR  
YOKE SCREW TOOL  
**Retail \$1.50**



**NO. 1696**  
TANK VALVE KEY  
SEALING COMPOUND  
(For securely inserting  
valves in tanks)  
**Retail \$2.75**



**NO. 1614**  
PRESSURE GAUGE AND YOKE  
WITH BLEEDER VALVE  
**Retail \$9.95**

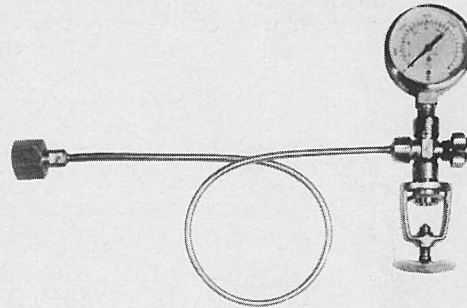

**NO. 1693**  
FILLER AND GAUGE COMBINATION  
WITH BLEEDER VALVE  
(For simultaneous tank refilling  
and pressure reading)  
**Retail \$17.95**

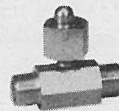

**NO. 1698**  
HIGH PRESSURE TEE  
**Retail \$4.95**



**NO. 1603-16**  
"O" RING ADAPTER  
Special compound Neoprene  
for High Pressure Valve  
**Retail \$ .20**



**NO. 1603-12**  
TEFLON WASHER  
(For No. 1603 High Pressure  
Valve or similar standard valve)  
**Retail \$ .25**

**NO. 1603-17**  
"O" RING  
Special Compound Neoprene  
for High Pressure Valve  
**Retail \$ .20**



3669 Seventh Avenue  
Los Angeles 18, California

# Scuba

PATS.  
PEND.

## SELF-CONTAINED UNDERWATER BREATHING APPARATUS REGULATOR

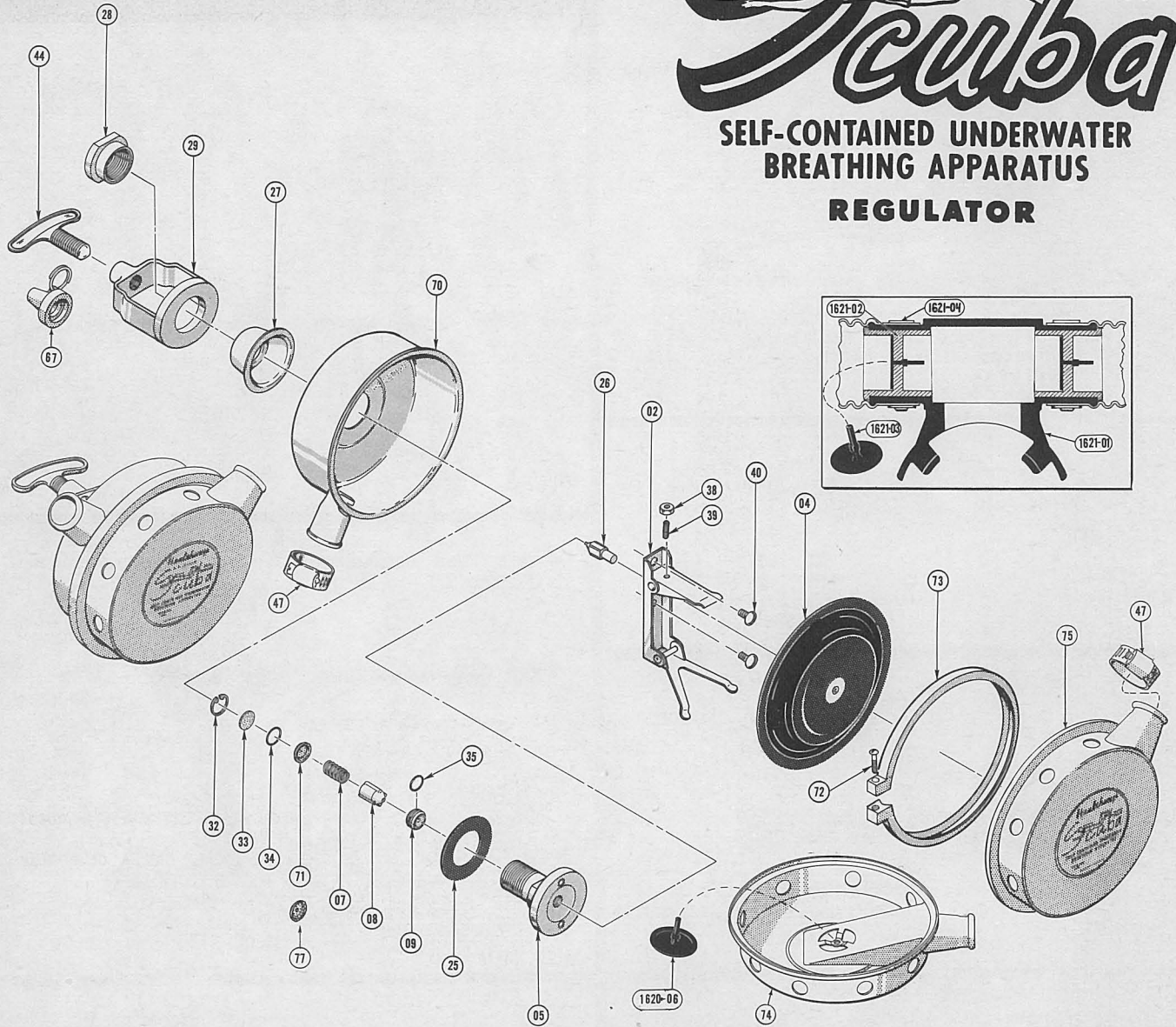

### REPLACEMENT PARTS NO. 1611 SCUBA REGULATOR

| CAT. NO. | DESCRIPTION                                 | RETAIL  | CAT. NO. | DESCRIPTION                                      | RETAIL |
|----------|---|---------|----------|--|--------|
| 1611-70  | Case, chrome plated brass                   | \$12.00 | 1611-39  | Set Screw, #10-32, stainless steel               | .25    |
| 1611-05  | Valve Body                                  | 5.00    | 1611-40  | Machine Screws, #10-32 x 5/16" stainless steel   | .25    |
| 1611-71  | K-Restrictor                                | .90     | 1611-44  | Yoke Screw, chrome plated brass                  | 1.50   |
| 1611-07  | Valve Spring, stainless steel               | .25     | 1611-47  | Hose Clamp, stainless steel                      | .75    |
| 1611-08  | Valve Plunger, nylon                        | .75     | 1611-72  | Cover Clamp Screw, #4-40 x 5/8", stainless steel | .50    |
| 1611-09  | Valve Seat, nickle plated brass             | 1.50    | 1611-73  | Cover Clamp, chrome plated brass                 | 1.95   |
| 1611-74  | Cover, chrome plated brass                  | 4.00    | 1611-77  | "J" Restrictor                                   | .25    |
| 1611-25  | Gasket, neoprene                            | .25     | 1601-01  | Rubber Hose, Yellow, one only                    | 2.50   |
| 1611-26  | Actuating pin, stainless steel              | 1.25    | 1620-06  | Rubber Flapper Valve                             | .25    |
| 1611-27  | Spacer, chrome plated brass                 | 1.00    | 1621-01  | Mouthpiece body, rubber                          | 3.00   |
| 1611-28  | Yoke Nut, chrome plated brass               | .80     | 1621-02  | Nylon Insert                                     | .25    |
| 1611-29  | Yoke, chrome plated brass                   | 4.00    | 1621-03  | Non-Return Rubber Valve                          | .25    |
| 1611-32  | Retaining Ring, Bright copper nickle plated | .25     | 1912     | "Underwater Safety" by E. R. Cross               | 1.00   |
| 1611-33  | Sintered Filter, nickle plated copper       | .50     | 1611-02  | SCUBA LINKAGE ASSEMBLY                           | 2.75   |
| 1611-34  | Restrictor "O" Ring                         | .25     | 1611-04  | SCUBA DIAPHRAGM ASSEMBLY                         | 4.50   |
| 1611-35  | Valve Seat "O" Ring                         | .25     | 1611-67  | PROTECTION CAP AND RING ASSEMBLY                 | .75    |
| 1611-38  | Hex Nut, #10-32, stainless steel            | .25     | 1611-75  | SCUBA COVER ASSEMBLY                             | 12.00  |



# RUBBER EXPOSURE SUITS

## CORONADO FOAM NEOPRENE SUIT

(Made of 1/8" high stretch material — one skin on inside — complete suit includes hood, long shirt with supporter Apron, exclusive butterfly-seal collar and long pants and boots. "Easy-to-put-on" design with full-length heavy duty, giant zipper on shirt front. Yellow stripping.

### COMPLETE SUITS

| No.      | Size    | Retail  |
|----------|---------|---------|
| No. 1760 | X-Small | \$46.50 |
| No. 1757 | Small   | 46.50   |
| No. 1758 | Medium  | 46.50   |
| No. 1759 | Large   | 46.50   |
| No. 1761 | X-Large | 46.50   |

### SHIRTS ONLY

| No.         | Size    | Retail  |
|-------------|---------|---------|
| No. 1760-01 | X-Small | \$24.50 |
| No. 1757-01 | Small   | 24.50   |
| No. 1758-01 | Medium  | 24.50   |
| No. 1759-01 | Large   | 24.50   |
| No. 1761-01 | X-Large | 24.50   |

### HOOD ONLY

| No.         | Size   | Retail |
|-------------|--------|--------|
| No. 1757-04 | Small  | \$4.00 |
| No. 1758-04 | Medium | 4.00   |
| No. 1759-04 | Large  | 4.00   |

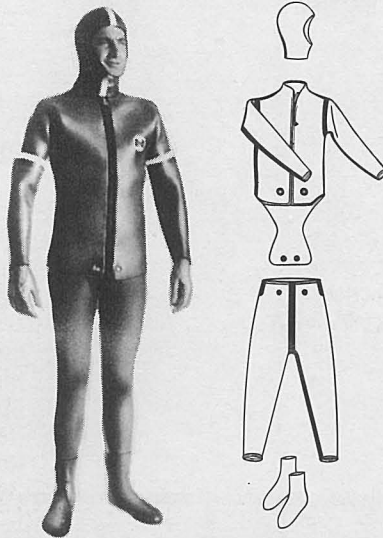

### PANTS ONLY

| No.         | Size    | Retail  |
|-------------|---------|---------|
| No. 1760-02 | X-Small | \$18.00 |
| No. 1757-02 | Small   | 18.00   |
| No. 1758-02 | Medium  | 18.00   |
| No. 1759-02 | Large   | 18.00   |
| No. 1761-02 | X-Large | 18.00   |

### BOOTS ONLY

| No.         | Size   | Retail |
|-------------|--------|--------|
| No. 1757-05 | Small  | \$4.00 |
| No. 1758-05 | Medium | 4.00   |
| No. 1759-05 | Large  | 4.00   |

**NO. 1794**  
CORONADO FOAM  
NEOPRENE REPAIR KIT  
Retail \$2.50

## SIZE CHART FOR ALL HEALTHWAYS SUITS

|             | Waist     | Weight    | Height       |
|-------------|-----------|-----------|--------------|
| Extra Small | 26" - 30" | 100 - 135 | 5'2" - 5'6"  |
| Small       | 30" - 34" | 135 - 160 | 5'5" - 5'9"  |
| Medium      | 32" - 36" | 155 - 180 | 5'7" - 6'0"  |
| Large       | 34" - 38" | 175 - 210 | 5'10" - 6'1" |
| Extra Large | 38" - 42" | 210 - 240 | 6'0" - 6'4"  |

## CORONADO DELUXE FOAM NEOPRENE SUIT

Made of 3/16" heavy duty, high-stretch material — skin on two sides. (Includes hood, long shirt with supporter Apron, exclusive butterfly-seal collar and long pants and boots. Exclusive new "Easy-to-put-on" design with full length new heavy duty, giant zipper on shirt front. Yellow stripping.

### SHIRTS ONLY

| No.         | Size    | Retail  |
|-------------|---------|---------|
| No. 1750-01 | X-Small | \$30.50 |
| No. 1767-01 | Small   | 30.50   |
| No. 1768-01 | Medium  | 30.50   |
| No. 1769-01 | Large   | 30.50   |
| No. 1751-01 | X-Large | 30.50   |

### HOOD ONLY

| No.         | Size   | Retail |
|-------------|--------|--------|
| No. 1767-04 | Small  | \$6.00 |
| No. 1768-04 | Medium | 6.00   |
| No. 1769-04 | Large  | 6.00   |

### COMPLETE SUITS

| No.      | Size    | Retail  |
|----------|---------|---------|
| No. 1750 | X-Small | \$58.50 |
| No. 1767 | Small   | 58.50   |
| No. 1768 | Medium  | 58.50   |
| No. 1769 | Large   | 58.50   |
| No. 1751 | X-Large | 58.50   |

### PANTS ONLY

| No.         | Size    | Retail  |
|-------------|---------|---------|
| No. 1750-02 | X-Small | \$22.00 |
| No. 1767-02 | Small   | 22.00   |
| No. 1768-02 | Medium  | 22.00   |
| No. 1769-02 | Large   | 22.00   |
| No. 1751-02 | X-Large | 22.00   |

### BOOTS ONLY

| No.         | Size   | Retail |
|-------------|--------|--------|
| No. 1767-05 | Small  | \$5.00 |
| No. 1768-05 | Medium | 5.00   |
| No. 1769-05 | Large  | 5.00   |

## CORONADO DELUXE FOAM NEOPRENE SUIT

Made of 1/4" heavy duty, high-stretch material — skin on two sides. (Includes hood, long shirt with supporter Apron, exclusive butterfly-seal collar and long pants and boots. Exclusive new "Easy-to-put-on" design with full length new heavy duty, giant zipper on shirt front. Yellow stripping.

### COMPLETE SUITS

| No.      | Size    | Retail  |
|----------|---------|---------|
| No. 1863 | X-Small | \$64.50 |
| No. 1864 | Small   | 64.50   |
| No. 1865 | Medium  | 64.50   |
| No. 1866 | Large   | 64.50   |
| No. 1867 | X-Large | 64.50   |



3669 Seventh Avenue  
Los Angeles 18, California

# RUBBER EXPOSURE SUITS

## "Do It Yourself" Kits

**CORONADO FOAM NEOPRENE SUIT "DO-IT-YOURSELF" KIT.** Made of 1/8" high stretch material. All material is pre-cut—comes complete with cement, stripping and detailed instructions. Heavy duty brass zipper and buttons already installed.

|          |         | <b>Retail</b> |
|----------|---------|---------------|
| No. 1752 | X-Small | \$29.95       |
| No. 1754 | Small   | 29.95         |
| No. 1755 | Medium  | 29.95         |
| No. 1756 | Large   | 29.95         |
| No. 1753 | X-Large | 29.95         |

**CORONADO DELUXE FOAM NEOPRENE "DO-IT-YOURSELF" KIT.** Made of 3/16" heavy duty high-stretch material. All material is pre-cut—comes complete with cement, stripping and detailed instructions. Heavy duty brass zipper and buttons already installed.

|          |         | <b>Retail</b> |
|----------|---------|---------------|
| No. 1748 | X-Small | \$43.50       |
| No. 1764 | Small   | 43.50         |
| No. 1765 | Medium  | 43.50         |
| No. 1766 | Large   | 43.50         |
| No. 1749 | X-Large | 43.50         |

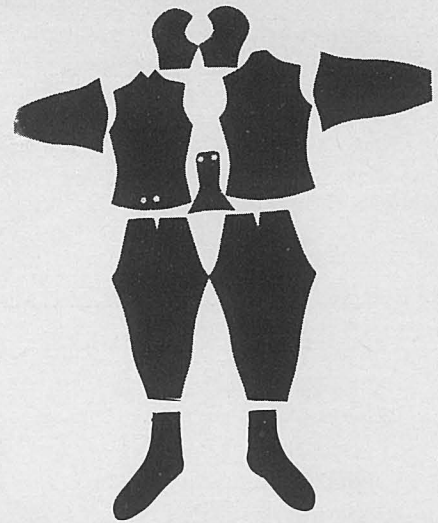

## CORONADO DELUXE FOAM NEOPRENE "DO-IT-YOURSELF" KIT.

Made of 1/4" extra heavy duty high stretch material. All material pre-cut. Comes complete with cement, stripping and detailed instructions. Heavy duty brass zipper and buttons already installed.

|                 |         | <b>Retail</b>  |
|-----------------|---------|----------------|
| <b>NO. 1853</b> | X-Small | <b>\$54.50</b> |
| <b>NO. 1854</b> | Small   | <b>54.50</b>   |
| <b>NO. 1855</b> | Medium  | <b>54.50</b>   |
| <b>NO. 1856</b> | Large   | <b>54.50</b>   |
| <b>NO. 1857</b> | X-Large | <b>54.50</b>   |



**NO. 1798**  
ORIGINAL BLACK MAGIC  
FOAM NEOPRENE CEMENT  
**Retail \$1.25**

**NO. 1791**  
RUBBER DUST  
(1/2 lb. squeeze bottle—  
concentrated powdered  
hydrous silicate of  
magnesium talc)  
**Retail \$ .60**



## WATER SKI AND SKIN DIVING JACKETS

### BALBOA FOAM NEOPRENE JACKET

|                 |         | <b>Retail</b>  |
|-----------------|---------|----------------|
| <b>No. 2774</b> | X-Small | <b>\$17.95</b> |
| <b>No. 2770</b> | Small   | <b>17.95</b>   |
| <b>No. 2771</b> | Medium  | <b>17.95</b>   |
| <b>No. 2772</b> | Large   | <b>17.95</b>   |
| <b>No. 2773</b> | X-Large | <b>17.95</b>   |

### AQUAFEMME

Woman's Water Ski and Diving Jackets,  
Foam Neoprene with Yellow collar and trim.

|                 |         | <b>Retail</b>  |
|-----------------|---------|----------------|
| <b>NO. 2800</b> | X-Small | <b>\$17.95</b> |
| <b>NO. 2801</b> | Small   | <b>17.95</b>   |
| <b>NO. 2802</b> | Medium  | <b>17.95</b>   |
| <b>NO. 2803</b> | Large   | <b>17.95</b>   |
| <b>NO. 2804</b> | X-Large | <b>17.95</b>   |





## SKIN DIVING ACCESSORIES

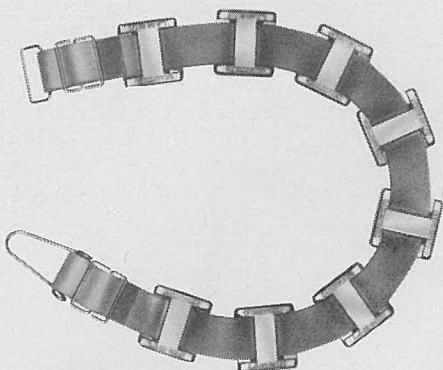

**NO. 1942**  
 PROFESSIONAL LEAD WEIGHT BELT—Complete 8 LBS.  
 (2" Web)  
 Includes:  
 No. 1942-01 1 lb. "Sandwich" Lead Weights (8)  
 No. 1942-02 2" Professional Web Belt with  
 Jet-O-Sen Quick Release Safety Buckle  
 Assembly  
**Retail \$10.95**

**NO. 1943**  
 PROFESSIONAL DELUXE LEAD WEIGHT BELT  
 Complete — 12 lbs. (2" web)  
**Retail \$14.95**

Includes:  
**1943-01** 2 lb. "Sandwich" Lead Weights (6)  
**1942-02** 2" Professional Web Belt with Jet-O-Sen  
 Quick Release safety buckle assembly.

**NO. 1944**  
 PROFESSIONAL DELUXE LEAD WEIGHT BELT  
 Complete — 15 lbs. (2" web)  
**Retail \$17.95**

Includes:  
**1944-01** 3 lbs. "Sandwich" Lead Weights (5)  
**1942-02** 2" Professional Web Belt with Jet-O-Sen  
 Quick Release safety buckle assembly.

**NO. 1942-02**  
 PROFESSIONAL WEIGHT BELT  
 (2" Web with Jet-O-Sen safety  
 buckle assembly)  
**Retail \$2.95**

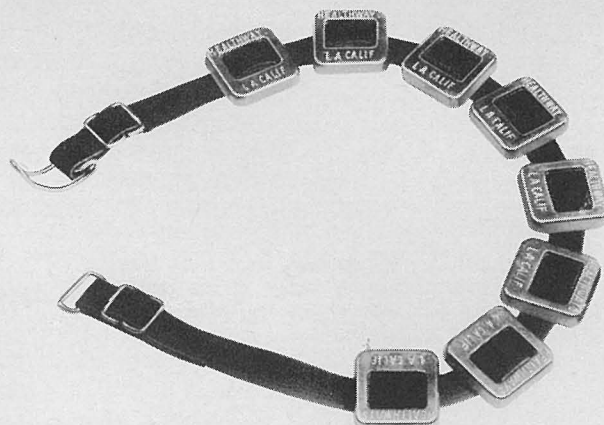

**NO. 1916**  
 LEAD WEIGHT BELT—Complete 8 LBS.  
 (1" Web)  
 Includes:  
 No. 1916-01 1 lb. Lead Weights (8)  
 No. 1916-02 1" Extra Heavy Web Belt  
 with stainless steel Jet-O-Sen  
 Quick Release safety buckle.  
**Retail \$9.95**

**NO. 1916-02**  
 UNDERWATER WEIGHT BELT—Without Weights  
 (1" Web with Jet-O-Sen Quick Release safety  
 buckle assembly)  
**Retail \$2.50**

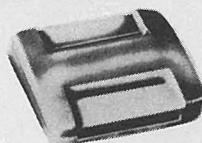

**NO. 1942-01**  
 1 LB. "SANDWICH" LEAD WEIGHT  
 (Fits 2" Web Belt)  
**Retail \$1.00 ea.**

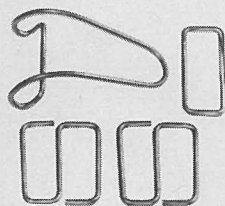

**NO. 1916-03**  
 JET-O-SEN 1" SAFETY BUCKLE ASSEMBLY  
 Stainless Steel—4 pcs.  
 (Fits 1" to 1 1/8" Web Belts and Scuba  
 harness)  
**Retail \$1.65**

**NO. 1942-03**  
 JET-O-SEN 2" SAFETY BUCKLE ASSEMBLY  
 Stainless Steel—4 pcs.  
 (Fits 2" to 2 1/8" Web Belts and  
 Scuba harness)  
**Retail \$1.75**

**NO. 1943-01**  
 2 LB. "SANDWICH"  
 LEAD WEIGHT  
 (Fits 2" Web Belt)  
**Retail \$2.00**

**NO. 1944-01**  
 3 LB. "SANDWICH"  
 LEAD WEIGHT  
 (Fits 2" Web Belt)  
**Retail \$3.00**



**NO. 1916-01**  
 1 LB. LEAD WEIGHT  
 Fits 1" Web Belt  
**Retail \$1.00 ea.**



3669 Seventh Avenue  
 Los Angeles 18, California

# SKIN DIVING ACCESSORIES

**NO. 1955**  
**ESPADON KNIFE**  
**AND SHEATH**  
**Retail \$8.95**

An exceptionally strong stainless steel knife with aluminum handle—Exclusive design of the sheath permits attaching to calf of the leg—the proper positioning for skin diving knives.

**NO. 1953**  
**ESPADON KNIFE ONLY**  
**Retail \$5.95**

**NO. 1954**  
**ESPADON SHEATH ONLY**  
**Retail \$3.00**

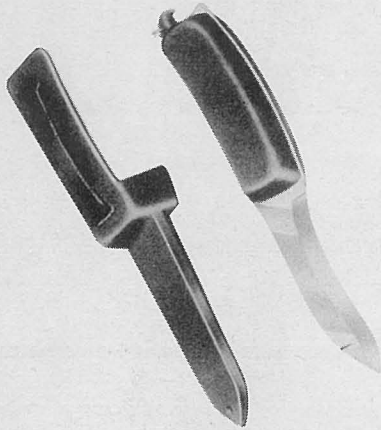
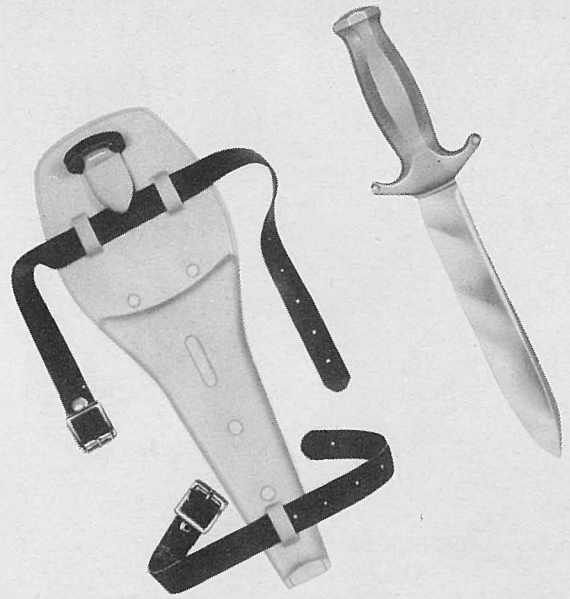

**NO. 1934**  
**CRESSI CORSAIR**  
**Retail \$3.95**

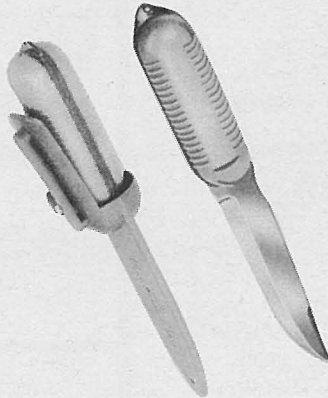

**NO. 1939**  
**CRESSI TOLEDO**  
**Retail \$4.95**



**NO. 1941**  
**SPORTSMAN**  
**Retail \$4.95**

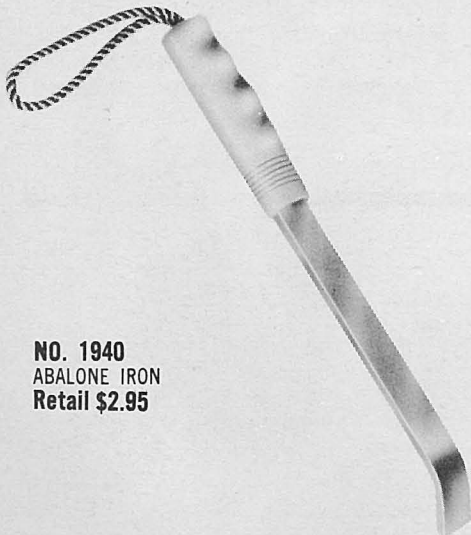

**NO. 1940**  
**ABALONE IRON**  
**Retail \$2.95**

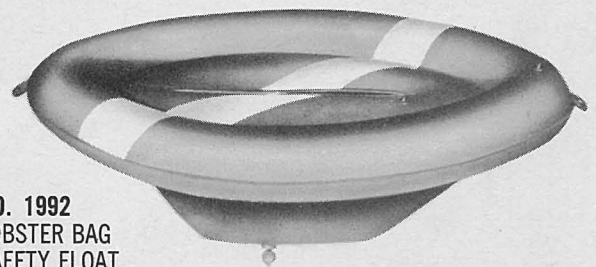

**NO. 1992**  
**LOBSTER BAG**  
**SAFETY FLOAT**  
**Retail \$6.95**

48" x 30". The most practical Lobster Bag ever designed, and an excellent safety and marker float. Zipper pocket—inflatable rim. Made of heavy duty vinyl.

## SKIN DIVING ACCESSORIES

**NO. 1945**  
AQUASTAR DELUXE AUTOMATIC  
UNDERWATER WATCH  
Retail \$79.95

A completely new watch designed especially for the diver with all these important features: automatic self-winding, bezel moving dial to record diving time, calendar window, luminous markings, anti-magnetic and the finest 17 jewel movement with One Year Guarantee. Imported from JeanRichard, Geneva, Switzerland.



**NO. 1946**  
AQUASTAR UNDERWATER WATCH  
Retail \$34.50

A Diver's watch from the world famous JeanRichard of Switzerland. 17 Jewel, Stem Wound Movement, Luminous markings, Anti-Magnetic. One Year Guarantee from JeanRichard of Switzerland.

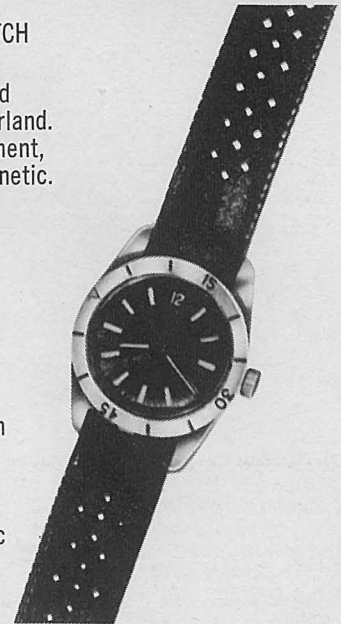

**NO. 1947**  
AQUASTARLET AUTOMATIC  
UNDERWATER WATCH  
Retail \$49.95

The finest compact size watch with all these outstanding features: Automatic Self-Winding, Bezel moving dial to record diving time, Luminous markings, Anti-Magnetic and a superb 17 Jewel movement with One Year Guarantee from JeanRichard of Switzerland.

**NO. 1964**  
SUBMARINE LIQUID COMPASS  
Retail \$5.95



**NO. 1956**  
200 FT.  
DIVERS DEPTH GAUGE  
Retail \$8.95

Corrosion proof chrome plated brass housing, rubber encased with form-fitting wrist strap.



**NO. 1959**  
250 FT. AQUASTAR  
PROFESSIONAL COMPASS AND  
DEPTH GAUGE COMBINATION  
Retail \$14.95

The most precise compass and depth gauge combination—heavy chrome plated brass. Curved wrist-fitting housing. Saltwater impervious strap.

**UNDERWATER  
DEPTH GAUGES  
AND COMPASSES**

**NO. 1958**  
200 FT. DIVERS COMBINATION  
COMPASS AND DEPTH GAUGE  
Retail \$10.95

Corrosion proof chrome plated brass housing, rubber encased with form-fitting wrist strap.



**NO. 1957**  
250 FT. AQUASTAR  
PROFESSIONAL DEPTH GAUGE  
Retail \$12.95

The most precise divers gauge—heavy chrome plated brass. Curved wrist-fitting housing. Saltwater impervious strap.

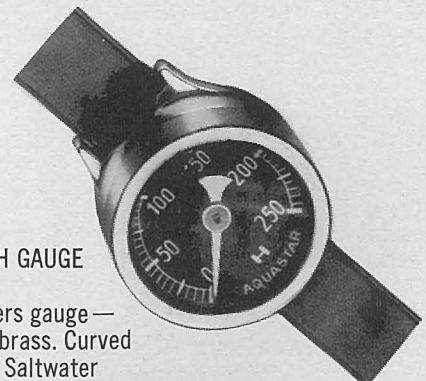

3669 Seventh Avenue  
Los Angeles 18, California

# SKIN DIVING ACCESSORIES



**NO. 1950**  
 MAKO SHARK UNDERWATER FLASH CAMERA  
 (Complete, self-contained standard BC  
 unit—first popular-price dual purpose  
 amphibious camera. Does not include battery  
 —uses standard 15 volt battery.)  
**Retail \$36.90**

**NO. 1950-90**  
 MAKO "CUDA" (BC) FLASH ATTACHMENT  
 for Mako Shark Flash camera—  
 for use underwater or above)  
**Retail \$6.95**

**NO. 1960**  
 MAKO SHARK FLASH CAMERA  
 ONLY—Without Flash  
**Retail \$29.95**

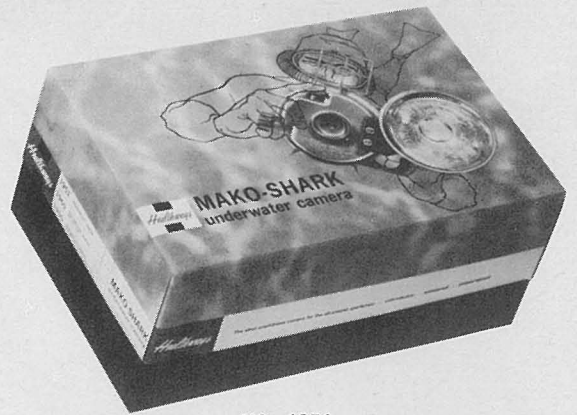

**NO. 1951**  
 MAKO SHARK UNDERWATER CAMERA  
 World's first popular-price  
 amphibious still camera.  
 (Uses standard 620 film roll,  
 twelve 2 1/4" x 2 1/4" pictures)  
**Retail \$19.95**



**NO. 3125**  
 SEA HORSE SKIN DIVERS FLOAT—30"x 68"  
 (Blue and Red—heavy duty brass grommets and  
 specially treated rope—a floating base and  
 comfortable float for the skin diver and swimmer)  
**Retail \$19.95**



**NO. 1912**  
 "UNDERWATER SAFETY"  
 by E. R. Cross  
**Retail \$1.00**

**NO. 1969**  
 INFLATABLE DIVERS FLAG  
**Retail \$1.95**

The most sensational divers safety flag ever devised. Heavy duty vinyl. Inflatable rim . . . it remains unfurled at all times.

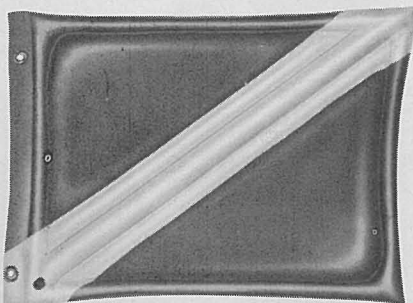

**NO. 1970**  
 AQUATABS  
 (Nutritional supplement to reduce fatigue, increase endurance and guard against deficiencies due to muscular exhaustion and nervous strain. 18 capsules in a flip-top vial—enough for 6 dives.)  
**Retail \$3.95**

**NO. 1971**  
 M.V.'s—MULTI VITAMINERAL SUPPLEMENT  
 (A high potency Multi Vitamineral product recommended for sportsmen, athletes and body building. Packed 120 capsules to a bottle, an average month's supply.)  
**Retail \$6.95**

# GOGGLES MASKS FINs

## and Accessories

### REPLACEMENT PARTS

| CAT. NO.    | DESCRIPTION                               | RETAIL EACH |
|-------------|---|-------------|
| <b>1103</b> | <b>Aqua-Pro Goggle</b>                    |             |
| 1103-02     | Tempered Glass Lens                       | .40         |
| 1103-03     | Straps                                    | .18         |
| 1101-04     | Buckle                                    | .06         |
| <b>1204</b> | <b>Aqua-Pro Mask</b>                      |             |
| 1204-02     | Lucite Lens (Clear — triangle)            | .35         |
| 1204-03     | Straps                                    | .25         |
| 1204-04     | Buckle                                    | .06         |
| 1204-60     | Band Assembly Complete                    | .33         |
| <b>1205</b> | <b>Professional Mask (Blue)</b>           |             |
| 1205-02     | Lens (Double Strength Glass)              | .85         |
| 1205-03     | Strap                                     | .65         |
| 1205-04     | Buckles                                   | .06         |
| 1205-60     | Band Complete                             | .65         |
| <b>1206</b> | <b>Professional Deluxe Mask (Blue)</b>    |             |
| 1206-02     | Lens (Tempered Glass — safety lens)       | 1.25        |
| 1205-03     | Strap                                     | .65         |
| 1205-04     | Buckles                                   | .06         |
| 1205-60     | Band Assembly Complete                    | .65         |
| <b>1209</b> | <b>Aqua-Champ Senior Mask (Natural)</b>   |             |
| 1209-02     | Lucite Lens (Clear)                       | .45         |
| 1208-03     | Straps                                    | .15         |
| 1101-04     | Buckle                                    | .06         |
| <b>1210</b> | <b>Aqua-King Mask</b>                     |             |
| 1210-02     | Lucite Lens (Clear — oval)                | .67         |
| 1210-03     | Straps                                    | .38         |
| 1210-04     | Buckle                                    | .06         |
| <b>1212</b> | <b>Professional Deluxe Mask (Natural)</b> |             |
| 1206-02     | Lens (Tempered Glass) — Safety            | 1.25        |
| 1212-03     | Strap                                     | .65         |
| 1205-04     | Buckles                                   | .05         |
| 1205-60     | Band Assembly Complete                    | .65         |
| <b>1220</b> | <b>Espadon</b>                            |             |
| <b>1222</b> | <b>Panoramique</b>                        |             |
| <b>1223</b> | <b>Compensator</b>                        |             |
| 1222-02     | Lens — Tempered Safety Glass              | 1.25        |
| 1222-03     | Strap                                     | .80         |
| 1222-04     | Buckles for Strap                         | .10         |
| 1222-60     | Band Assembly Complete                    | .65         |
| <b>1230</b> | <b>Pinocchio Diving Mask (patented)</b>   |             |
| 1230-02     | Lens (Tempered Glass)                     | 1.70        |
| 1230-08     | Strap                                     | .65         |
| 1230-04     | Brass Buckle                              | .10         |
| 1230-60     | Band Assembly Complete                    | .70         |
| <b>1241</b> | <b>Ostrica</b>                            |             |
| 1231-02     | Lens (Tempered Glass)                     | 1.25        |
| 1240-03     | Strap                                     | .65         |
| 1230-04     | Brass Buckle                              | .10         |
| 1231-60     | Band Assembly Complete                    | .92         |
| <b>1235</b> | <b>Medusa (Twin Snorkel)</b>              |             |
| 1234-02     | Lens (Tempered Safety Glass)              | 2.00        |
| 1235-03     | Triangle Strap                            | .65         |
| 1230-04     | Brass Buckle                              | .10         |
| 1232-05     | Valve                                     | 1.10        |
| 1234-06     | Snorkel Tube (Plastic)                    | .23         |
| 1234-07     | Band Assembly                             | .53         |

| CAT. NO.         | DESCRIPTION                                 | RETAIL EACH |
|------------------|---|-------------|
| <b>1236</b>      | <b>Scuba Full-face Diving Mask</b>          |             |
| 1230-02          | Lens (Tempered Safety Glass)                | 1.70        |
| 1235-03          | Triangle Strap                              | .65         |
| 1230-04          | Brass Buckle                                | .10         |
| <b>1239</b>      | <b>Ostrica Junior Mask</b>                  |             |
| 1239-02          | Lens (Tempered Safety Glass)                | .75         |
| 1239-03          | Strap                                       | .65         |
| 1239-04          | Buckles for Strap                           | .10         |
| <b>1240</b>      | <b>Baby Ostrica</b>                         |             |
| 1240-02          | Lens (Tempered Safety Glass)                | .75         |
| 1240-03          | Strap                                       | .50         |
| 1240-04          | Buckles for Strap                           | .10         |
| <b>1334</b>      | <b>Rondine Swim Fin—Large (9-11)</b>        |             |
| 1334-03          | Strap                                       | .65         |
| 1302-04          | Buckle                                      | .10         |
| <b>1335</b>      | <b>Rondine Swim Fin—X Large (11-13)</b>     |             |
| 1335-03          | Strap                                       | .65         |
| 1303-04          | Buckle                                      | .10         |
| <b>1357-1358</b> | <b>Cressi Gigante Fins Competition Type</b> |             |
| 1357-03          | Strap                                       | .65         |
| 1303-04          | Buckle                                      | .10         |
| <b>1302</b>      | <b>Small Water Dogs</b>                     |             |
| 1302-03          | Strap                                       | .28         |
| 1302-04          | Buckles                                     | .10         |
| <b>1303</b>      | <b>Standard Water Dogs — Medium</b>         |             |
| 1303-03          | Strap                                       | .38         |
| 1303-04          | Buckles                                     | .10         |
| <b>1304</b>      | <b>Standard Water Dogs — Large</b>          |             |
| 1303-03          | Strap                                       | .38         |
| 1303-04          | Buckles                                     | .10         |
| <b>1307</b>      | <b>Standard Web Feet—Small—Medium</b>       |             |
| 1307-03          | Strap                                       | .40         |
| 1303-04          | Buckles                                     | .10         |
| <b>1308</b>      | <b>Standard Web Feet—Medium—Large</b>       |             |
| 1307-03          | Strap                                       | .40         |
| 1303-04          | Buckles                                     | .10         |
| <b>1402</b>      | <b>Aqua-Champ Snorkel Swim Pipe</b>         |             |
| 1402-07          | Mouthpiece                                  | .43         |
| 1402-08          | Headband                                    | .30         |
| 1402-09          | Rubber Ball                                 | .06         |
| <b>1430</b>      | <b>Delfino Snorkel</b>                      |             |
| 1430-07          | Mouthpiece                                  | 1.30        |
| 1430-11          | Gum Rubber Tube                             | .38         |
| 1430-05          | Plastic Tube                                | .30         |
| <b>1403</b>      | <b>Sea Scout Snorkel</b>                    |             |
| 1403-07          | Mouthpiece                                  | .20         |
| 1402-08          | Headband                                    | .24         |
| <b>1432</b>      | <b>Haiti Snorkel</b>                        |             |
| 1432-07          | Mouthpiece                                  | 1.00        |
| 1432-01          | Tube  | 1.25        |



3669 Seventh Avenue  
Los Angeles 18, California

**ESPADON ARBALETES**

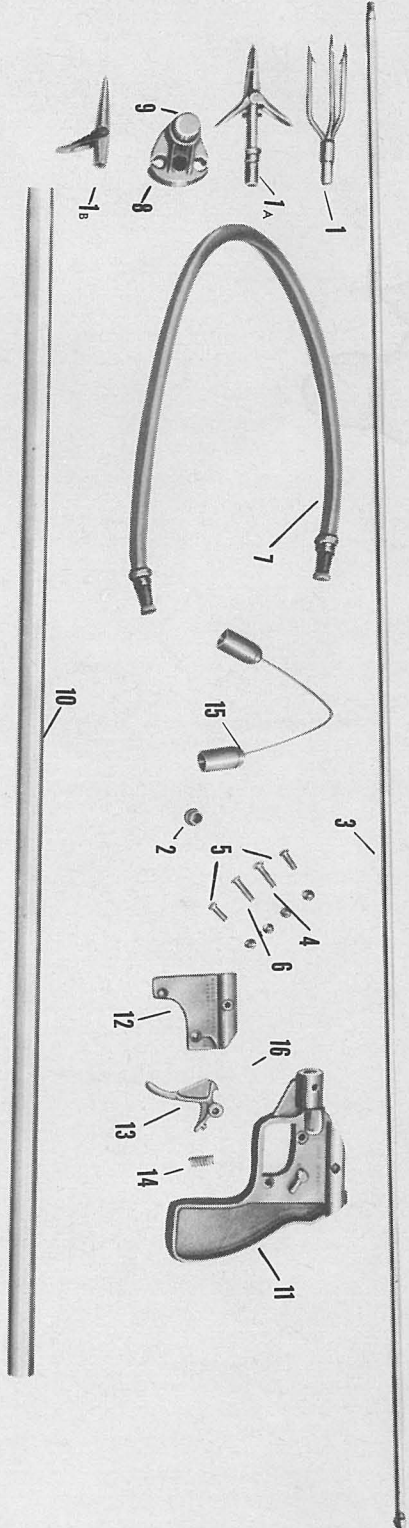

| 1507—BANTAM ESPADON |          |  | 1508—JUNIOR ESPADON |          |  | 1509—STANDARD ESPADON |          |  |
|---------------------|----------|--|---------------------|----------|--|-----------------------|----------|--|
| Illust. No.         | Cat. No. | Description  | Illust. No.         | Cat. No. | Description  | Illust. No.           | Cat. No. | Description  |
| 1                   | 1507-02  | Tri Point Spearhead                                | 1a                  | 1504-02  | Single Barb Spearhead                              | 1a                    | 1505-02  | Double Barb Spearhead                              |
| 2                   | 1507-03  | Slide Ring   | 2                   | 1507-03  | Slide Ring   | 2                     | 1507-03  | Slide Ring   |
| 3                   | 1507-04  | Bare Shaft   | 3                   | 1508-04  | Bare Shaft   | 3                     | 1509-04  | Bare Shaft   |
| 4                   | 1507-05  | Top Cover Plate Screw                              | 4                   | 1507-05  | Top Cover Plate Screw                              | 4                     | 1507-05  | Top Cover Plate Screw                              |
| 5                   | 1507-06  | Bottom Cover Plate Screw                           | 5                   | 1507-06  | Bottom Cover Plate Screw                           | 5                     | 1507-06  | Bottom Cover Plate Screw                           |
| 6                   | 1507-07  | Rear Barrel Screw                                  | 6                   | 1507-07  | Rear Barrel Screw                                  | 6                     | 1507-07  | Rear Barrel Screw                                  |
| 7                   | 1507-08  | Power Sling  | 7                   | 1508-08  | Power Sling  | 7                     | 1509-08  | Power Sling  |
| 8                   | 1507-09  | Muzzle   | 8                   | 1507-09  | Muzzle   | 8                     | 1507-09  | Muzzle   |
| 9                   | 1507-10  | Muzzle Barrel Screw                                | 9                   | 1507-10  | Muzzle Barrel Screw                                | 9                     | 1507-10  | Muzzle Barrel Screw                                |
| 10                  | 1507-11  | Barrel   | 10                  | 1508-11  | Barrel   | 10                    | 1509-11  | Barrel   |
| 11                  | 1507-13  | Pistol Grip Casting                                | 11                  | 1507-13  | Pistol Grip Casting                                | 11                    | 1507-13  | Pistol Grip Casting                                |
|                     |          | Includes: Safety Lever, Eccentric Disc and Spring. |                     |          | Includes: Safety Lever, Eccentric Disc and Spring. |                       |          | Includes: Safety Lever, Eccentric Disc and Spring. |
| 12                  | 1507-16  | Pistol Grip Cover Plate                            | 12                  | 1507-16  | Pistol Grip Cover Plate                            | 12                    | 1507-16  | Pistol Grip Cover Plate                            |
| 13                  | 1507-18  | Trigger  | 13                  | 1507-18  | Trigger  | 13                    | 1507-18  | Trigger  |
| 14                  | 1507-19  | Trigger Spring                                     | 14                  | 1507-19  | Trigger Spring                                     | 14                    | 1507-19  | Trigger Spring                                     |
| 15                  | 1507-26  | Wishbone Wire                                      | 15                  | 1504-26  | Wishbone Wire                                      | 15                    | 1504-26  | Wishbone Wire                                      |
| 16                  | 1507-17  | Safety Spring                                      | 16                  | 1507-17  | Safety Spring                                      | 16                    | 1507-17  | Safety Spring                                      |
|                     | 1507-60  | Shaft Complete                                     |                     | 1508-60  | Spear Shaft Complete                               |                       | 1509-60  | Spear Shaft Complete                               |
|                     |          | Retail \$1.75                                      |                     |          | Retail \$ .98                                      |                       |          | Retail \$1.98                                      |
|                     |          | .20  |                     |          | .20  |                       |          | .20  |
|                     |          | 1.34   |                     |          | 1.50   |                       |          | 1.60   |
|                     |          | .15  |                     |          | .15  |                       |          | .15  |
|                     |          | .15  |                     |          | .15  |                       |          | .15  |
|                     |          | .15  |                     |          | .15  |                       |          | .15  |
|                     |          | 2.25   |                     |          | 2.50   |                       |          | 2.50   |
|                     |          | .50  |                     |          | .50  |                       |          | .50  |
|                     |          | .15  |                     |          | .15  |                       |          | .15  |
|                     |          | 4.46   |                     |          | 6.00   |                       |          | 6.69   |
|                     |          | 4.79   |                     |          | 4.79   |                       |          | 4.79   |
|                     |          | 1.40   |                     |          | 1.40   |                       |          | 1.40   |
|                     |          | .83  |                     |          | .83  |                       |          | .83  |
|                     |          | .32  |                     |          | .32  |                       |          | .32  |
|                     |          | 1.25   |                     |          | 1.25   |                       |          | 1.25   |
|                     |          | .32  |                     |          | .32  |                       |          | .32  |
|                     |          | 3.35   |                     |          | 3.15   |                       |          | 4.35   |

To insure replacement of proper small gun parts we suggest defective part be returned when ordering.



3669 Seventh Avenue  
Los Angeles 18, California

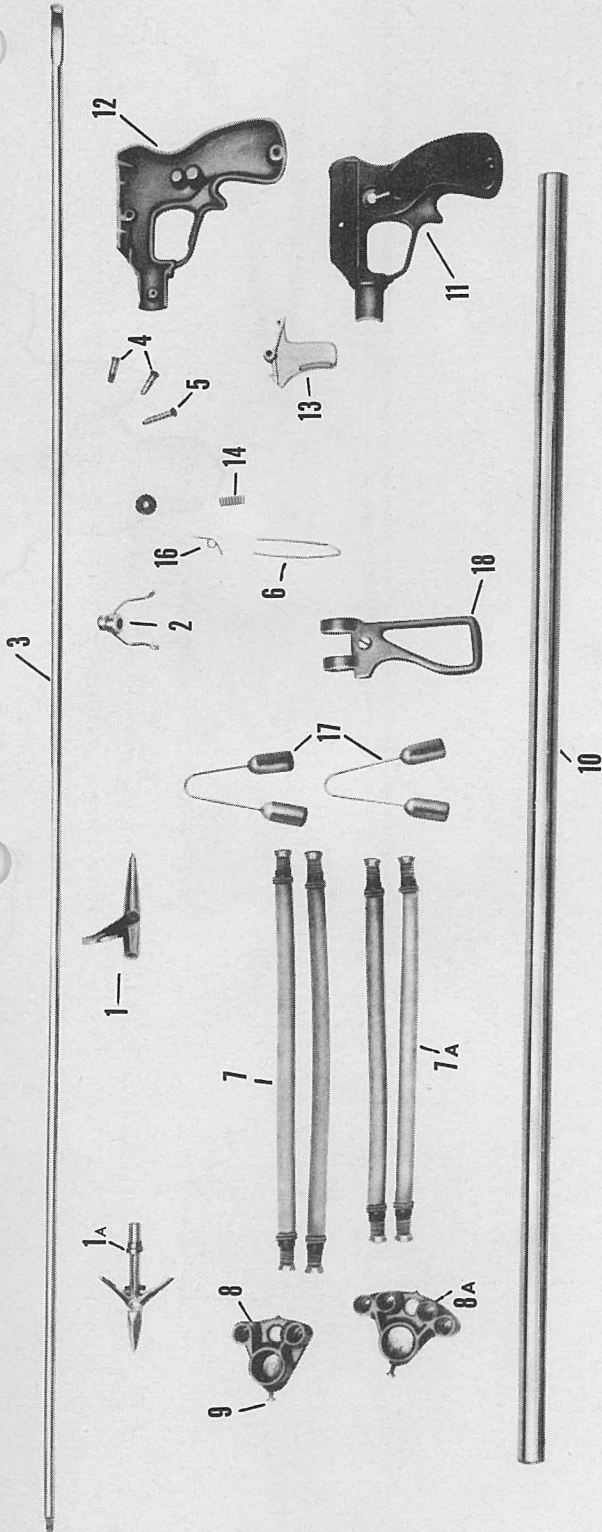

1504—PECHE SPORT JUNIOR ARBALETE

| Illust. No. | Cat. No. | Description                                       | Retail |
|-------------|----------|---|--------|
| 1           | 1504-02  | Single Barb Spearhead                             | \$ .98 |
| 2           | 1504-03  | Slide Ring  | .40    |
| 3           | 1504-04  | Bare Shaft  | 1.85   |
| 4           | 1504-05  | Machine Screws (2 req.)                           | .15    |
| 5           | 1504-06  | Barrel Screw                                      | .32    |
| 6           | 1504-07  | Spring Clamp Wire                                 | .32    |
| 7           | 1504-08  | Power Rubber 1 pr. 1/2 set                        | 1.60   |
| 8           | 1504-09  | Muzzle  | 3.43   |
| 9           | 1504-10  | Barrel  | .10    |
| 10          | 1504-11  | Barrel  | 6.44   |
| 11          | 1504-13  | Pistol Grip Casting                               | 12.18  |
| 12          | 1504-16  | Includes Safety Lever, Eccentric Disc and Spring. | 1.40   |
| 13          | 1504-18  | Pistol Grip Cover Plate                           | 1.28   |
| 14          | 1504-19  | Trigger   | .32    |
| 15          | 1504-19  | Trigger Spring                                    | .32    |
| 16          | 1507-17  | Safety Spring                                     | .32    |
| 17          | 1504-26  | Wishbone Wire                                     | 1.25   |
| 18          | 1504-60  | Spear Shaft Complete                              | 3.80   |

1505—PECHE SPORT STANDARD ARBALETE

| Illust. No. | Cat. No. | Description                                       | Retail |
|-------------|----------|---|--------|
| 1           | 1505-02  | Double Barb Spearhead                             | \$1.98 |
| 2           | 1504-03  | Slide Ring  | .40    |
| 3           | 1505-04  | Bare Shaft  | 2.30   |
| 4           | 1504-05  | Machine Screws (2 req.)                           | .15    |
| 5           | 1504-06  | Barrel Screw                                      | .32    |
| 6           | 1504-07  | Spring Clamp Wire                                 | .32    |
| 7           | 1505-08  | Power Rubber 1 pr. 1/2 set                        | 1.85   |
| 8           | 1504-09  | Muzzle  | 3.43   |
| 9           | 1504-10  | Muzzle Screw                                      | .10    |
| 10          | 1504-11  | Barrel  | 7.84   |
| 11          | 1504-13  | Pistol Grip Casting                               | 12.18  |
| 12          | 1504-16  | Includes Safety Lever, Eccentric Disc and Spring. | 1.40   |
| 13          | 1504-18  | Pistol Grip Cover Plate                           | 1.28   |
| 14          | 1504-19  | Trigger   | .32    |
| 15          | 1504-19  | Trigger Spring                                    | .32    |
| 16          | 1507-17  | Safety Spring                                     | .32    |
| 17          | 1504-26  | Wishbone Wire                                     | 1.25   |
| 18          | 1505-60  | Spear Shaft Complete                              | 4.45   |

1506—PECHE SPORT DELUXE ARBALETE

| Illust. No. | Cat. No. | Description                                       | Retail |
|-------------|----------|---|--------|
| 1           | 1505-02  | Double Barb Spearhead                             | \$1.98 |
| 2           | 1504-03  | Slide Ring  | .40    |
| 3           | 1506-04  | Bare Shaft  | 2.60   |
| 4           | 1504-05  | Machine Screws (2 req.)                           | .15    |
| 5           | 1504-06  | Barrel Screw                                      | .32    |
| 6           | 1506-07  | Spring Clamp Wire                                 | .32    |
| 7           | 1506-08  | Power Rubber 1 pr. 1/4 set                        | 1.85   |
| 7a          | 1505-08  | Power Sling 1 pr. 1/4 set                         | 1.85   |
| 8           | 1506-09  | Muzzle  | 4.97   |
| 9           | 1504-10  | Muzzle Screw                                      | .10    |
| 10          | 1506-11  | Barrel  | 6.44   |
| 11          | 1504-13  | Pistol Grip Casting                               | 12.18  |
| 12          | 1504-16  | Includes Safety Lever, Eccentric Disc and Spring. | 1.40   |
| 13          | 1504-18  | Pistol Grip Cover Plate                           | 1.28   |
| 14          | 1504-19  | Trigger   | .32    |
| 15          | 1504-19  | Trigger Spring                                    | .32    |
| 16          | 1507-17  | Safety Spring                                     | .32    |
| 17          | 1504-26  | Wishbone Wire                                     | 1.25   |
| 18          | 1506-27  | Center Grip Handle                                | 3.50   |
| 19          | 1506-60  | Spearshaft Complete                               | 5.00   |

HAWAIIAN SLING SPEAR GUN PARTS

| Cat. No. | Item                | Retail |
|----------|---------------------|--------|
| 1502-08  | Power Sling         | \$ .80 |
| 1502-04  | Standard Spear      | 1.75   |
| 1502-25  | Gun Only (No Spear) | 2.75   |

To insure replacement of proper small gun parts we suggest defective part be returned when ordering.



3669 Seventh Avenue  
Los Angeles 18, California

**CRESSI SPEAR GUNS**

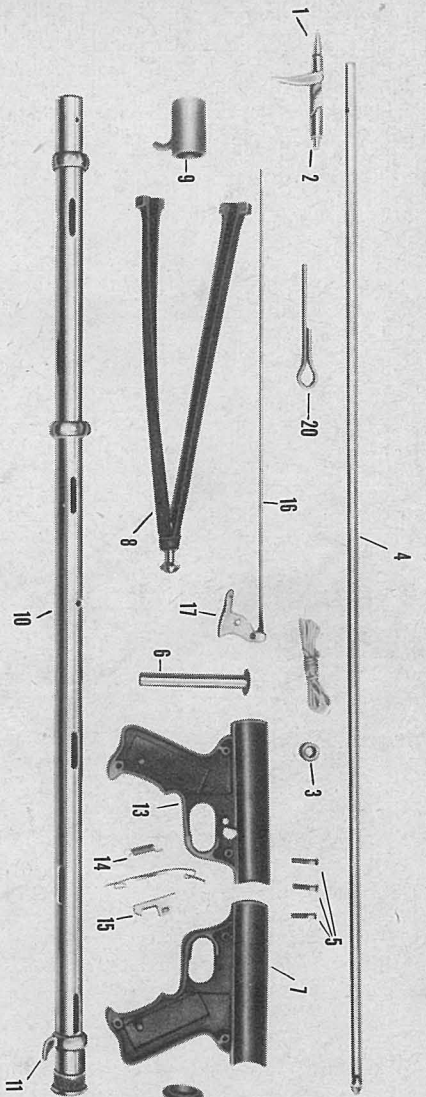

**1531—CRESSI SAETTA**

| Illust. No. | Cat. No. | Description             | Retail |
|-------------|----------|-------------------------|--------|
| 1           | 1534-01  | Spearhead Tip           | \$ .40 |
| 2           | 1534-02  | Single Barb             | 1.25   |
| 3           | 1534-03  | Slide Ring              | .20    |
| 4           | 1531-04  | Bare Shaft              | 2.96   |
| 5           | 1531-05  | Top Grip Screw (3 req.) | .07    |
| 6           | 1531-06  | Bottom Grip Screw       | 3.14   |
| 7           | 1531-07  | Right Hand Grip Plate   | 3.14   |
| 8           | 1531-08  | Power Spring            | 4.21   |
| 9           | 1531-09  | Front Line Hold         | 1.33   |
| 10          | 1531-10  | Barrel (Includes 09)    | 10.93  |
| 11          | 1531-11  | Rear Line Holder        | .74    |
| 12          | 1531-12  | Left Hand Grip Plate    | 4.25   |
| 13          | 1531-13  | Trigger Spring          | .15    |
| 14          | 1531-14  | Trigger                 | .96    |
| 15          | 1531-15  | Line Clamp Screw & Nut  | 2.75   |
| 16          | 1531-16  | Spear Release Plate     | .89    |
| 17          | 1531-17  | Spear Complete          | 4.60   |

**1534—CRESSI MIGNON**

| Illust. No. | Cat. No. | Description               | Retail |
|-------------|----------|---------------------------|--------|
| 1           | 1534-01  | Spearhead Tip             | \$ .40 |
| 2           | 1534-02  | Single Barb               | 1.25   |
| 3           | 1534-03  | Slide Ring                | .20    |
| 4           | 1534-04  | Bare Shaft                | 3.55   |
| 5           | 1534-05  | Top Grip Screw (3 req.)   | .07    |
| 6           | 1534-06  | Bottom Grip Screw         | 3.32   |
| 7           | 1534-07  | Right Hand Grip Plate     | 3.50   |
| 8           | 1534-08  | Power Rubber              | .59    |
| 9           | 1534-09  | Front Line Hold           | 9.75   |
| 10          | 1534-10  | Barrel (Includes 09 & 11) | 1.15   |
| 11          | 1534-11  | Rear Line Holder          | 37     |
| 12          | 1534-12  | Barrel Tip                | 4.43   |
| 13          | 1534-13  | Left Hand Grip Plate      | .15    |
| 14          | 1534-14  | Trigger Spring            | .96    |
| 15          | 1534-15  | Trigger                   | 2.59   |
| 16          | 1534-16  | Line Release Rod          | .22    |
| 17          | 1534-17  | Line Trigger              | .15    |
| 18          | 1534-18  | Charge Pin                | .15    |
| 19          | 1534-19  | Spear Complete            | 5.20   |
| 20          | 1534-20  | Spear Complete            | 5.20   |

Mignon Gun Parts 1534-01, 02, 03, 04, 08, and 11 are interchangeable with No. 1530 Mignon Plastic Gun.

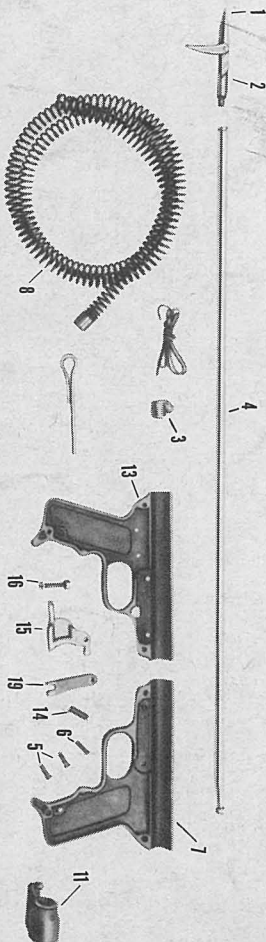

**1532—TORPEDINE**

Saetta Gun Parts 1531, 06, 07, 13, 14, 16, 19 and 20 are interchangeable with No. 1532 Torpedine and No. 1533 Cernia Guns.

| Cat. No. | Description  | Retail |
|----------|--------------|--------|
| 1532-04  | Bare Shaft   | 3.70   |
| 1532-08  | Power Spring | 5.00   |
| 1532-03  | Slide Ring   | .20    |

**1533—CERNIA**

| Cat. No. | Description  | Retail |
|----------|--------------|--------|
| 1533-03  | Slide Ring   | .22    |
| 1533-04  | Bare Shaft   | 4.00   |
| 1533-08  | Power Spring | 5.70   |